

fora collection



bejot:



Kasper Mose

en:

Architect, furniture and interior designer. Graduated from Aarhus School of Architecture in 2008 at the Institute of Design. He gained experience at top Danish design offices: Arkitema and Friis & Moltke Architects. In 2020 he opened his own design studio, where he seeks simplicity and a holistic approach to design.

pl:

Architekt, projektant mebli i wnętrz. Ukończył Aarhus School of Architecture w 2008 roku w Instytucie Designu. Doświadczenie zdobywał w najlepszych duńskich biurach projektowych – Arkitema i Friis & Moltke Architects. W 2020 roku otworzył własne studio projektowe, w którym poszukuje prostoty i holistycznego podejścia do projektowania.

de:

Architekt, Möbel- und Innenarchitekt. Er schloss sein Studium an der Aarhus School of Architecture im Jahr 2008 am Institute of Design ab. Er sammelte Erfahrungen bei den führenden dänischen Designbüros: Arkitema und Friis & Moltke Architects. Im Jahr 2020 eröffnete er sein eigenes Designstudio, in dem er nach Einfachheit und einem ganzheitlichen Ansatz für das Design strebt.

**Kasper Mose's
design is firmly
rooted in the
Danish design
tradition and
characterized
by simplicity,
functionality
and minimalism.**

be:soft
be:subtle
be:relaxed
be:homely
be:modular

bejot: of the world

:Straight lines on the outside

"The first thoughts about the FORA was to make a low comfortable lounge modular system who appeals to informal meetings, therefore the name FORA.

FORA is the Latin version of the word Forum, which means a place to gather, a place for dialog and interaction, often in a public space.

The design of the FORA is simple and minimalistic, but at the same time versatile and cosy. Straight lines on the outside and softer and more organic on the inside.

Though it looks like a classic sofa, the modularity and wide range of different composition makes it a perfect choice for office interiors and public spaces".

Kasper Mose
designer

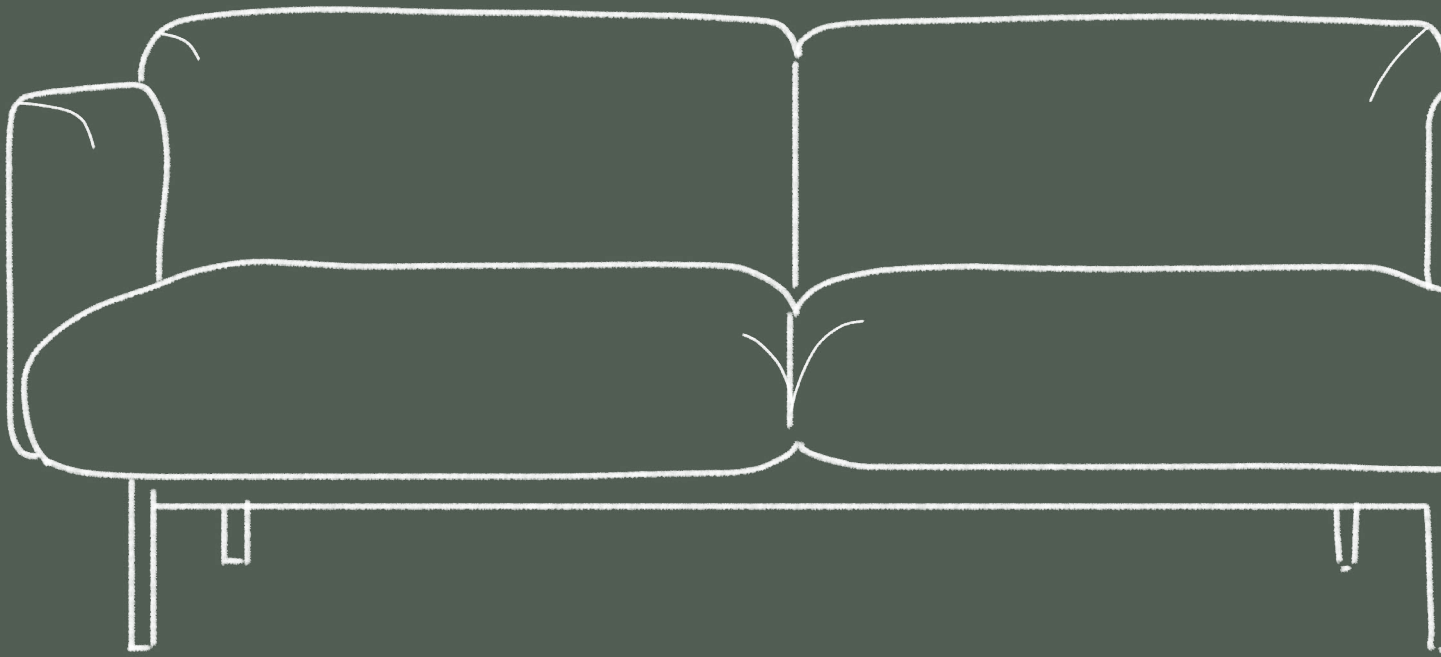

**and softer and
more organic
on the inside.**

**Characterized by
clean lines and
graphic details.**

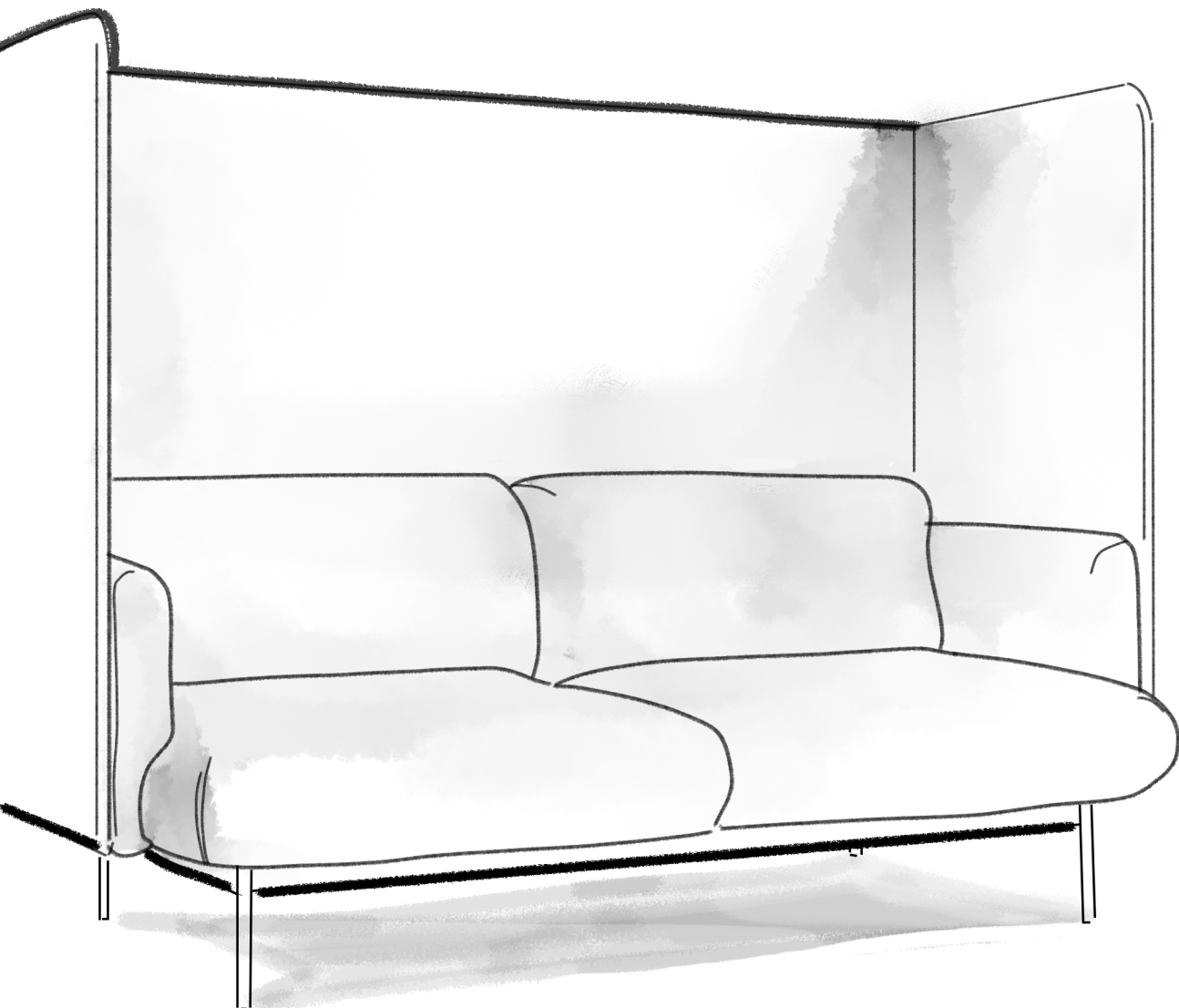

fora

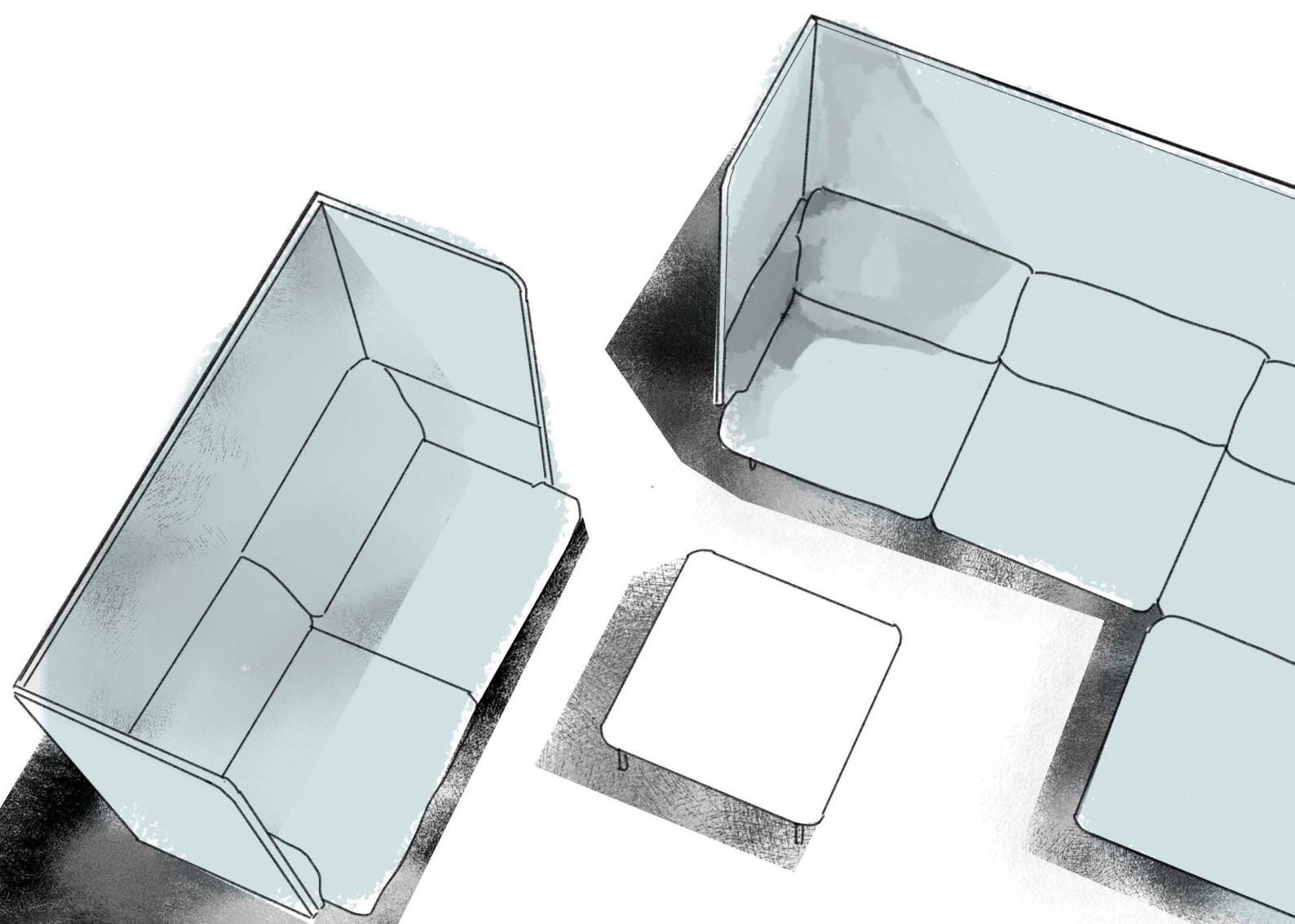
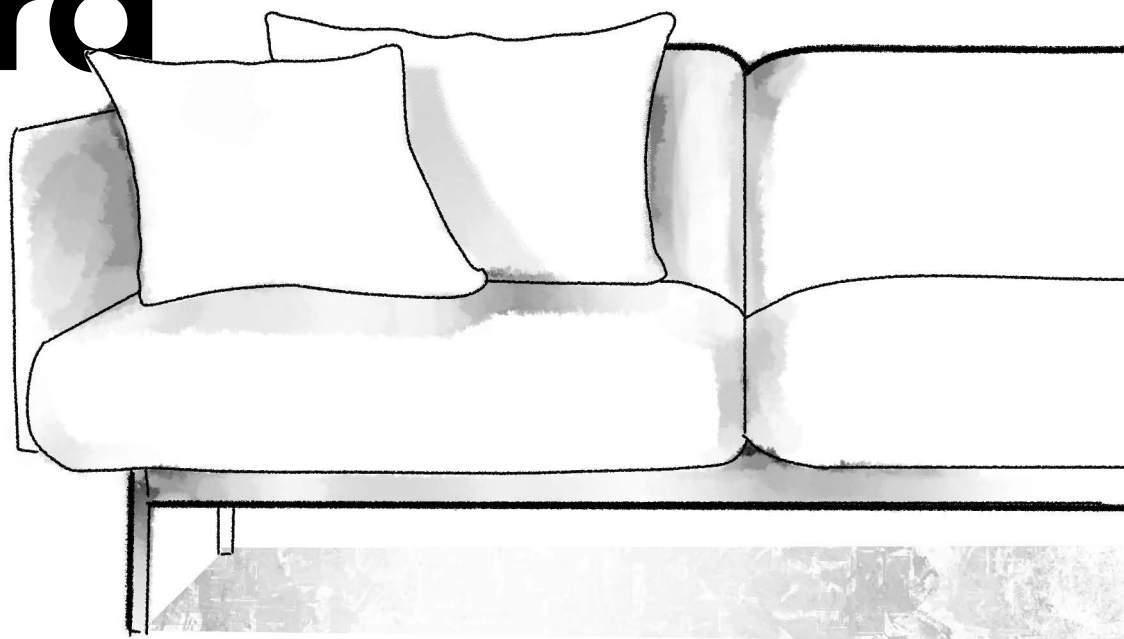



FR 100

Upholstered with Cura CR168
Metal finish RAL 9005 S

FR 422

Upholstered with Cura CR168
Metal finish RAL 9005 S

FR TB 13

Table top U999
Metal finish RAL 9005 S

fora

soft seating collection



en:

Danish design in a modern way

The collection was inspired by Danish design, whose key elements are organic lines and simple form. The minimalist frame of the base provides an intriguing contrast to the soft and spacious seats, backrests and cushions.

Fora successfully brings a sense of warmth and coziness to open office spaces and public areas.

pl:

Duńskie wzornictwo w nowoczesnym wydaniu

Inspiracją do stworzenia kolekcji było duńskie wzornictwo, którego kluczowymi elementami są organiczne linie oraz prosta forma. Minimalistyczna rama podstawy stanowi intrygujący kontrast dla miękkich i obszernych siedzisk, oparć oraz poduszek.

Fora z powodzeniem wprowadza do domu ciepło i przytulność w otwarte przestrzenie biurowe i publiczne.

de:

Dänisches Design mit einem modernen Touch

Die Kollektion wurde vom dänischen Design inspiriert, dessen Schlüsselemente einfache Linien und grafische Details sind. Das minimalistische Untergestell bildet einen spannenden Kontrast zu den weichen und voluminösen Sitzen, Rückenlehnen und Kissen.

Fora schafft es, heimelige Wärme und Gemütlichkeit in offene Büros und öffentliche Räume zu bringen und Gespräche schaffen.



FR 421
Upholstered with CUZ1R
Metal finish RAL 7047 S



FR 423
Upholstered with AP005
Metal finish RAL 9005 S



FR 411 L



FR 401



FR 412 R



FR 402



FR 100
Upholstered with AP005
Metal finish RAL 9005 S



FR 422
Upholstered with CUZ1R
Metal finish RAL RAL 7047 S



FR 413 R



FR 403

**FR 401S**

Upholstered with AP005
Metal finish RAL 9005 S

en:**A breath of modernity**

The chaise longue is a versatile yet elegant piece of furniture that adapts to a variety of settings. It can be used instead of any seat in all models except the corner and pouffe.

pl:**Powiew nowoczesności**

Szezlony to uniwersalny, a zarazem elegancki mebel dopasowujący się do zróżnicowanych aranżacji. Można go zastosować zamiast dowolnego siedziska we wszystkich modelach z wyjątkiem narożnika i pufy.

de:**Ein Hauch von Modernität**

Die Chaiselongue ist ein vielseitiges und elegantes Möbelstück, das sich an eine Vielzahl von Umgebungen anpasst. Er kann bei allen Modellen mit Ausnahme der Eck- und Pouffe-Modelle anstelle eines beliebigen Sitzes verwendet werden.

**FR 421S****FR 411S R****FR 4CC**

Upholstered with AP005
Metal finish RAL 9005 S





FR TB 13
Table top U999
Metal finish RAL 9005 S

FR FR 401S + FR 402 + FR 100
Upholstered with Cura CR009
Metal finish RAL 9005 S



en:

Possibility to combine individual modules

Putting different modules together is possible thanks to special connectors that allow you to create individual configurations.

pl:

Możliwość łączenia poszczególnych modułów

Zstawianie ze sobą poszczególnych modułów możliwe jest dzięki specjalnym łącznikom pozwalającym stworzyć indywidualne konfiguracje.

de:

Möglichkeit der Kombination einzelner Module

Die Module können mit speziellen Verbindern kombiniert werden, um individuelle Konfigurationen.

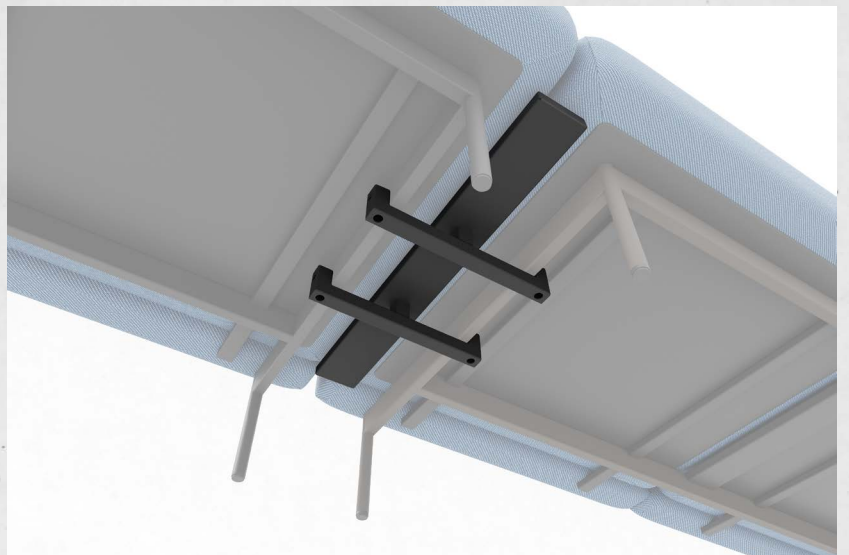



FR TB 13

Table top U999

Metal finish RAL 9005 S

FR FR 412 L + FR 4CC + FR 401

Upholstered with Oceanic OOC16

Metal finish RAL 9005 S

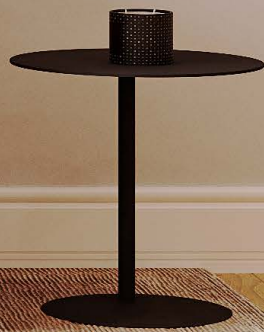



en:

Classics and design

The oblong or square tops of Fora tables can be made of laminated board or oak plywood.

pl:

Klasyka i design

Podłużne lub kwadratowe blaty stolików Fora mogą zostać wykonane z płyty laminowanej lub klejonyki dębowej.

de:

Klassiker und Design

Die länglichen oder quadratischen Platten der Fora-Tische können aus laminiertes Platte oder Eichensperrholz.

FR TB 65

Table top HPL black

Metal finish RAL 9005 S

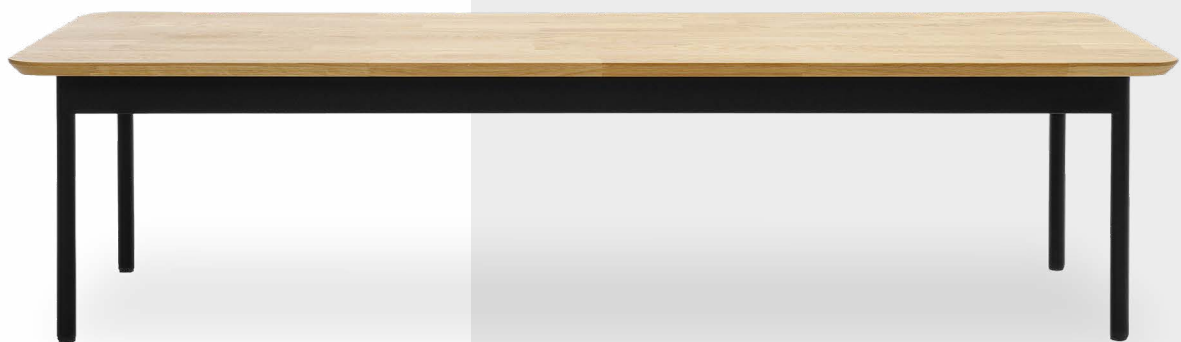

FR TB 13

Table top KDAB

Metal finish RAL 9005 S



FR TB 65

Table top U708
Metal finish RAL 7047 S

FR 421 W

Upholstered with Oceanic OOC16
Metal finish RAL 7047 S

FR 423 W

Upholstered with Oceanic OOC13
Metal finish RAL 7047 S

FR 100

Upholstered with Oceanic OOC13
Metal finish RAL 7047 S

play with modules!

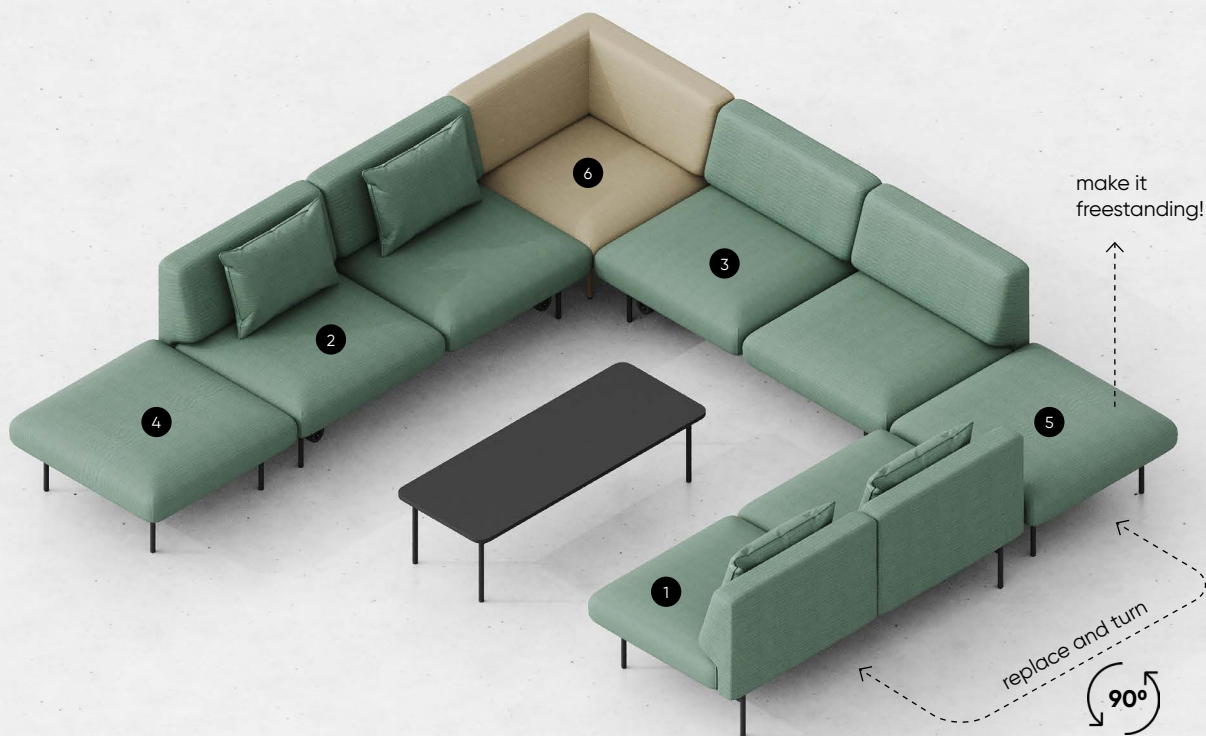
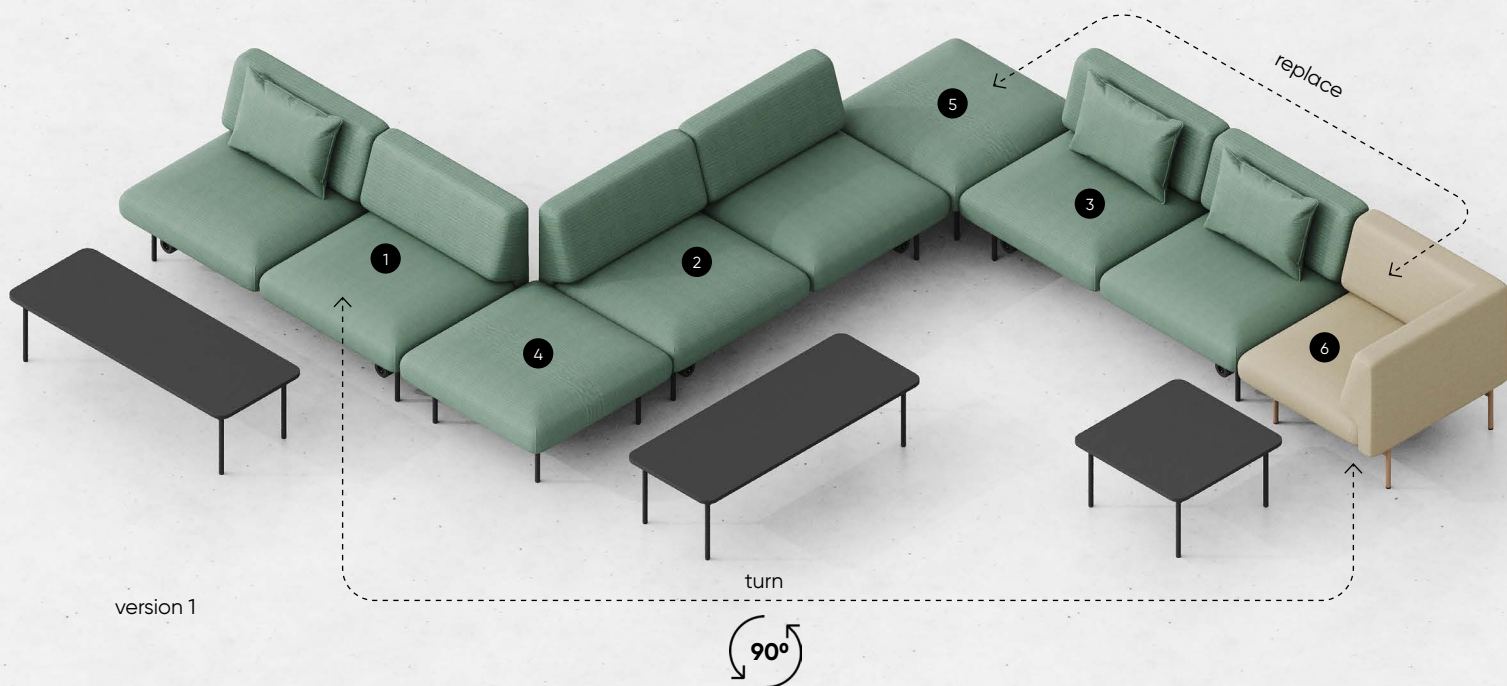

version 2



version 3

modules used:

3x

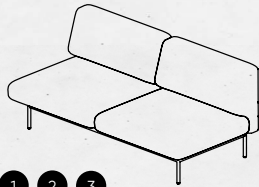

FR 402 1 2 3

2x



FR 100 4 5

1x

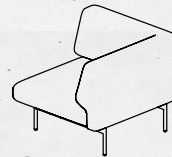

FR 4CC 6

connectors:

5x

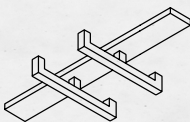

possible additions:



FR TB65



FR TB13



PP 60x45

en:

Mix as you please!

When you buy one set of Fora modular seating, you can create any diverse configurations you want.

pl:

Miksuj dowolnie!

Kupując jeden zestaw siedzisk modułowych Fora możesz tworzyć dowolne, zróżnicowane konfiguracje.

de:

Mischen und kombinieren Sie nach Belieben!

Mit dem Kauf eines Satzes modularer Fora-Sitzmöbel können Sie eine Vielzahl von Konfigurationen schaffen.

be:comfortable

the secret inside the cross-section

en:

Comfort and convenience

The soft upholstery foam and corrugated springs used in the production of the Fora sofa provide a sense of extraordinary comfort and convenience, while also influencing the absence of unsightly dents and deformation of the seat.

pl:

Wygoda i komfort

Miękka pianka tapicerska oraz sprężyny faliste wykorzystane do produkcji sofy Fora zapewniają poczucie niezwykłej wygody i komfortu, wpływając jednocześnie na brak nieestetycznych wgnieceń i odkształceń siedziska.

de:

Komfort und Bequemlichkeit

Der weiche Polsterschaum und die gewellten Federn, die bei der Herstellung des Sofas Fora verwendet werden, vermitteln ein Gefühl von außergewöhnlichem Komfort und Bequemlichkeit und haben gleichzeitig Einfluss auf das Fehlen von unschönen Beulen und Verformungen der Sitzfläche.

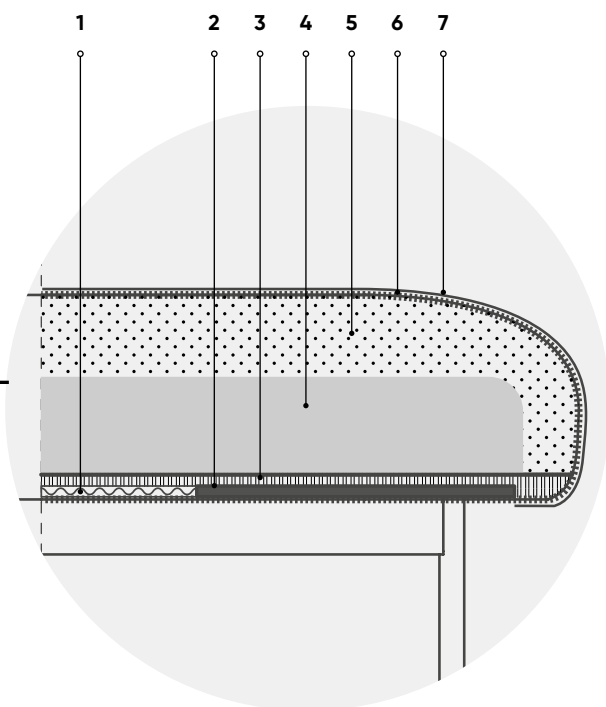

en:

- 1 - corrugated springs
- 2 - plywood
- 3 - felt
- 4 - highly flexible hard foam
- 5- soft high resilience foam
- 6 - sheepskin
- 7 - fabric

pl:

- 1 - sprężyny faliste
- 2 - sklejka
- 3 - filc
- 4 - pianka wysokoelastyczna twarda
- 5- pianka wysokoelastyczna miękka
- 6 - owata
- 7 - tkanina

de:

- 1 - gewellte Federn
- 2 - Sperrholz
- 3 - Filz
- 4 - hochflexibler Hartschaum
- 5 - weicher, hochelastischer Schaumstoff
- 6 - Schafsfell
- 7 - Stoff



be:intimate

space dividing acoustic walls



en:

Cosy spaces

A sofa and an armchair with acoustic walls allow to separate an intimate space corresponding to the entire collection. By filling the walls with a special sound-absorbing fleece, the furniture creates an additional acoustic surface in the room.

pl:

Kameralne przestrzenie

Na wydzielenie kameralnej przestrzeni korespondującej z całą kolekcją pozwalają sofa i fotel ze ściankami akustycznymi. Dzięki wypełnieniu ścianek specjalną, dźwiękochłonną włókniną meble tworzą dodatkową powierzchnię akustyczną w pomieszczeniu.

de:

Gemütliche Räume

Ein Sofa und ein Sessel mit Akustikwänden ermöglichen es, einen gemütlichen Raum zu schaffen, der der gesamten Kollektion entspricht. Die Wände sind mit einem speziellen Akustikvlies gefüllt, wodurch eine zusätzliche akustische Fläche im Raum entsteht.



FR TB 65
Table top W1000
Metal finish RAL 9003 S

FR 422 W
Upholstered with Oceanic OOC05
Metal finish RAL 9003 S

FR 423 W
Upholstered with Oceanic OOC05
Metal finish RAL 9003 S

FR 100
Upholstered with Oceanic OOC16
Metal finish RAL 9003 S

Order and harmony in the scandinavian style



FR TB 65
Table top W1000
Metal finish RAL 9003 S

FR 422 W
Upholstered with Ally AL653
Metal finish RAL 9003 S

FR 423 W
Upholstered with Ally AL653
Metal finish RAL 9003 S

FR 100
Upholstered with Ally AL653
Metal finish RAL 9003 S











FR 421 W

Upholstered with Oceanic OOC16

Metal finish RAL 9005 S

be:connected

possibilities for positioning mediaports



en:
**Possibility of installing
mediaports**

A few simple modules can be used to create functional social spaces. The installation of mediaports is a practical solution for the comfort and convenience of users.

pl:
**Możliwość zamontowania
mediaportów**

Z kilku prostych modułów można stworzyć funkcjonalne wspólne przestrzenie. Zamontowanie mediaportów to praktyczne rozwiązanie wpływające na komfort pracy i wygodę użytkowników.

de:
**Möglichkeit der Installation von
mediaports**

Mit ein paar einfachen Modulen lassen sich funktionale Sozialräume schaffen. Die Installation von Mediaports ist eine praktische Lösung für den Komfort und die Bequemlichkeit der Nutzer.

be:eco



en:

Environmentally responsible

The entire collection was designed with eco-friendly solutions in mind, in order to reduce the harmful impact of man on the environment as much as possible. Meanwhile, the high quality of the materials used guarantees the use of the sofa for years. In the production of Fora we do not use metal staples, which allows for easy replacement of upholstery, and after a period of use the product can be easily separated into individual parts - up to 98% of the furniture is recyclable.

pl:

Odpowiedzialni ekologicznie

Cała kolekcja została zaprojektowana z uwzględnieniem proekologicznych rozwiązań, aby jak najbardziej ograniczyć szkodliwy wpływ człowieka na środowisko. Natomiast wysoka jakość wykorzystanych materiałów gwarantuje użytkowanie sofy przez lata. Przy produkcji Fory nie używamy metalowych zszywek, co pozwala na łatwą wymianę tapicerki, a po okresie eksploatacji produkt można łatwo rozdzielić na poszczególne części - aż 98% mebla nadaje się do ponownego przetworzenia.

de:

Ökologisch verantwortlich

Die gesamte Kollektion wurde unter Berücksichtigung ökologischer Lösungen entworfen, um die schädlichen Auswirkungen des Menschen auf die Umwelt so weit wie möglich zu reduzieren. Gleichzeitig garantiert die hohe Qualität der verwendeten Materialien eine jahrelange Nutzung des Sofas. Bei der Herstellung von Fora werden keine Metallklammern verwendet, was einen einfachen Austausch der Polsterung ermöglicht. Nach einer gewissen Nutzungsdauer kann das Produkt leicht in seine Einzelteile zerlegt werden - bis zu 98 % der Möbel sind recycelbar.



Fabrics
Choose upholstery from our collection.



Recyclable foam
Soft high recyclable resilience foam.



Recyclable foam
Highly flexible recyclable hard foam.



Felt



Springs
Frame and springs made of plywood structure and high-strength steel.



Base
Powder painted steel base.



Feet
Plastic recyclable feet.

Fora sofas & modules

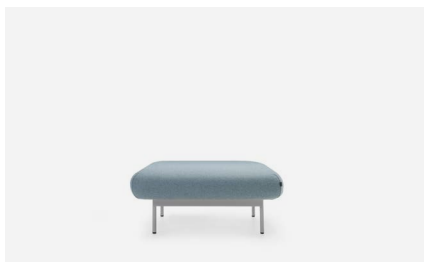

FR 100



FR 421



FR 422



FR 423



FR 411 R



FR 412 L



FR 413 R



FR 401



FR 402



FR 403

L - armrest on the left side of the sitting person
R - armrest on the right side of the sitting person

L - armrest on the left side of the sitting person
R - armrest on the right side of the sitting person

L - Armlehne auf der linken Seite einer sitzenden Person
R - Armlehne rechts von der sitzenden Person



FR 401S



FR 411S L



FR 4CC

Technical data

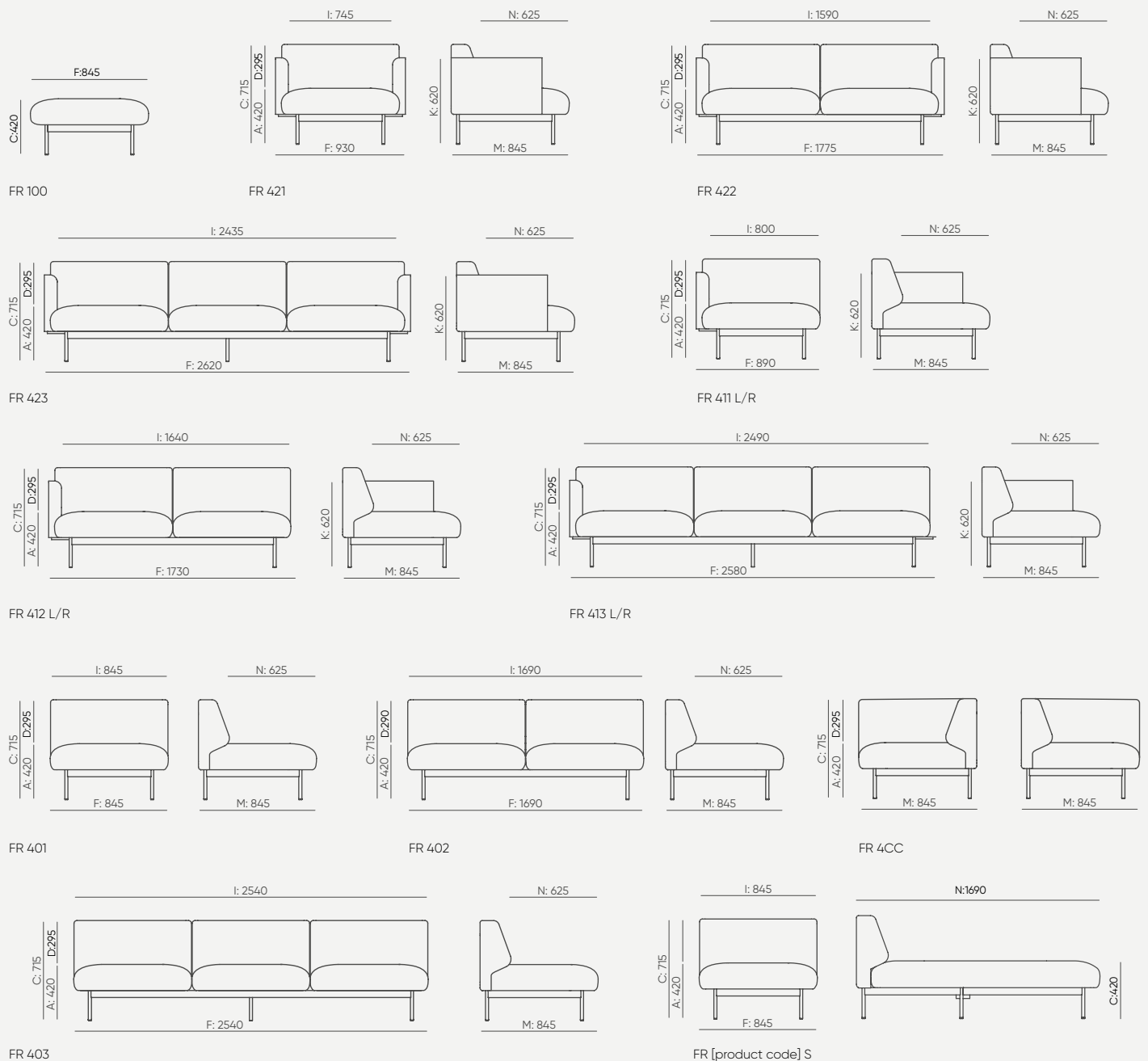

seat-to-seat connector /
 łącznik siedzisk z siedziskami /
 Sitz-Sitz-Anschluss

en:

Combining modules

The free-standing elements without armrests are compatible. They can easily be put together using a special connector.

pl:

Łączenie modułów

Elementy wolnostojące bez podłokietników są kompatybilne. W łatwy sposób można je ze sobą zestawiać za pomocą specjalnego łącznika.

de:

Kombinierte Module

Die freistehenden Elemente ohne Armlehnen sind kompatibel. Sie lassen sich mit einem speziellen Verbindungsstück leicht zusammenstecken.

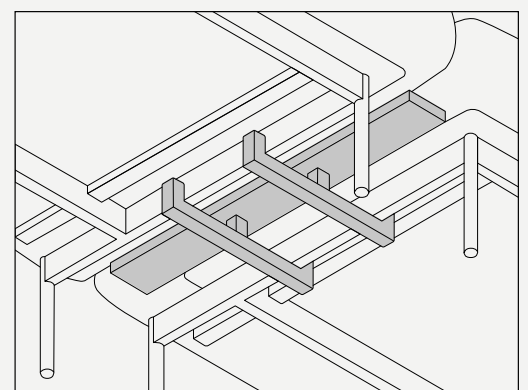

Fora sofas & modules



FR 421 W



FR 422 W



FR 423 W

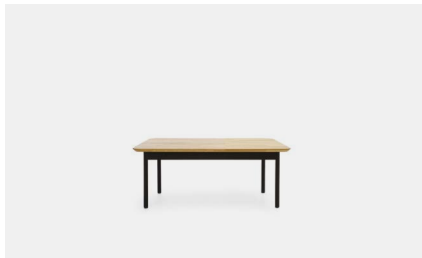

FR TB 65



FR TB 13



Milled tabletop / Frezowany blat / Gefräste Platte *

en:
Table top

Colors according to the Bejot sampler.

pl:
Blaty

Kolorystyka wg wzornika Bejot.

de:
Tischplatte

Farbgebung nach Bejot-Musterkatalog.

Laminated board / Plyta laminowana / Laminierter Platte



H1180



H3303



U999



U961



U708

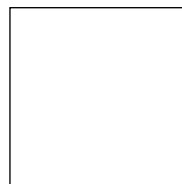

W1000

finger joint solid wood / klejonka dębowa / brett-schichtholz Eiche



KDAB

*Milled top available only for the finger joint solid wood version.

*Frezowany blat dostępny tylko dla wersji z klejonki dębowej.

*Die gefräste Platte ist nur für die Version aus brett-schichtholz Eiche erhältlich.



MEDIAPORT



Round PIX mediaport (black-B)
- 1 voltage socket 230 V



Round PIX mediaport (black-B)
- 2 x USB charger

Mediaports can be mounted under the seat (FR100, FR 4X1 - maximum 1 mediaport, FR 4X2, FR 4X3 - maximum 3 mediaports). Mediaports only in black.

Mediaporty mogą być zamontowane pod siedziskiem (FR100, FR 4X1 - maksymalnie 1 mediaport, FR 4X2, FR 4X3 - maksymalnie 3 mediaporty). Mediaporty wyłącznie w kolorze czarnym.

Mediaports können unter dem Sitz montiert werden (FR100, FR 4X1 - maximal 1 Mediaport, FR 4X2, FR 4X3 - maximal 3 Mediaports). Mediaports nur in schwarz.

Technical data

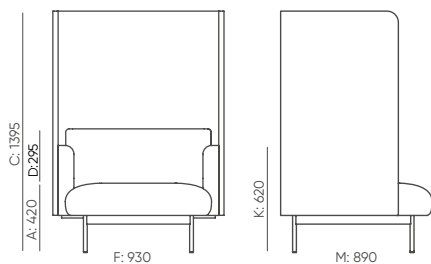

FR 421 W

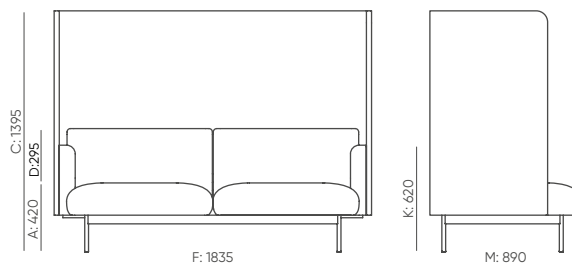

FR 422 W

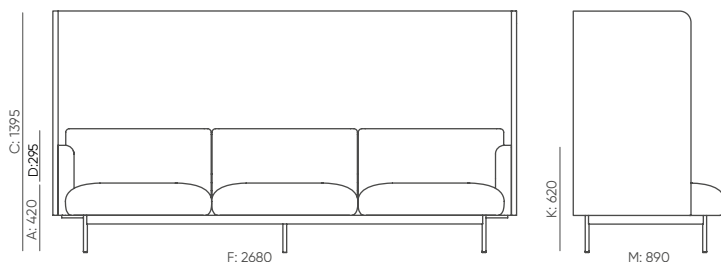

FR 423 W

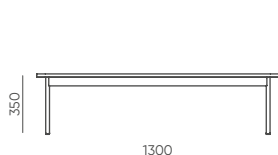

FR TB 13

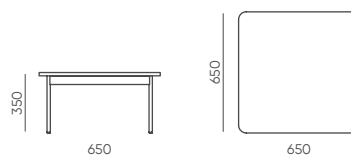

FR TB 65

en:

Dimensions and weights are approximate and may vary by 5%. The data is given for the basic configuration of products. The requirements of the standard are always met.

pl:

Wymiary i wagi mają charakter orientacyjny i mogą się różnić o 5%. Dane podane są do podstawowych konfiguracji produktów. Zawsze spełnione są wymogi normy.

de:

Abmessungen und Gewichte sind ungefähr und können um 5% variieren. Die Daten sind für die Grundkonfiguration von Produkten angegeben. Die Anforderungen der Norm werden immer erfüllt.

be:sustainable

product life-cycle management



en:

Bejot's synonyms for sustainability are: environmentally conscious action, safe products, and the organization of ergonomic areas for working and interacting, affecting the creativity and well-being of employees. No metal staples are used in the production of Fora, and the fabric is not glued to the foam. As a result, the product can be easily separated into individual parts after a lifetime - up to 98% of the furniture is recyclable. We also provide a 5-year warranty and post-warranty service, and introduce the principle of minimizing waste after the product's life cycle.

pl:

Synonimami zrównoważonego rozwoju Bejot są: świadome działanie w sposób przyjazny dla środowiska, bezpieczne produkty oraz organizacja ergonomicznych stref do pracy i współdziałania, wpływających na kreatywność i samopoczucie pracowników. Przy produkcji Fory nie używamy metalowych zszywek, a tkanina nie jest przyklejana do pianki. Dzięki temu po okresie eksploatacji produkt można łatwo rozdzielić na poszczególne części - aż 98% mebla nadaje się do ponownego przetworzenia. Zapewniamy również 5 lat gwarancji i serwis pogwarancyjny, a także wprowadzamy zasadę minimalizacji odpadów po zakończonym cyklu życia produktu.

de:

Die Synonyme für Nachhaltigkeit bei Bejot sind: bewusstes umweltfreundliches Handeln, sichere Produkte und die Einrichtung ergonomischer Arbeits- und Interaktionsbereiche, die sich auf die Kreativität und das Wohlbefinden der Mitarbeiter auswirken. Bei der Herstellung von Fora werden keine Metallklammern verwendet und der Stoff wird nicht mit dem Schaumstoff verklebt. Dadurch kann das Produkt nach seiner Lebensdauer leicht in seine Einzelteile zerlegt werden - bis zu 98 % der Möbel sind recycelbar. Außerdem bieten wir eine 5-Jahres-Garantie und einen Nachgarantieservice und führen das Prinzip der Abfallminimierung am Ende des Lebenszyklus des Produkts ein.

Fora collection – ecology and recycling

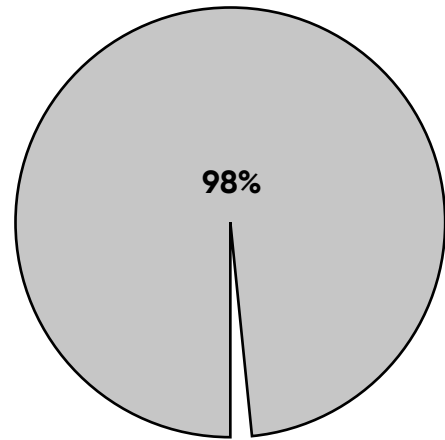
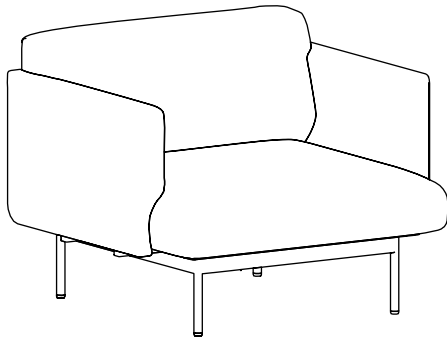

en:
We care about the environment

We use recyclable materials, e.g. in the sample Fora FR 421 presented above, we can reuse as much as 98% of the initial materials.

pl:
Dbamy o środowisko

Używamy materiałów podlegających recyklingowi, np. w powyższym przykładowym modelu Fora FR 421 możemy wyko-rzystać ponownie aż 98% mebla.

de:
Wir Schützen unsere Umwelt

Wir verwenden wiederverwertbare Mate-rialien, wie z.B. bei den Fora FR 421 oben, können wir bis zu 98% des Möbelstücks wiederverwenden.



wood / drewno / Holz



steel / stal / Stahl

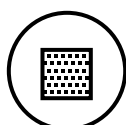

foam / pianka / Schaum

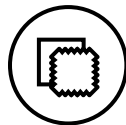

upholstery / tapicerka / Polster

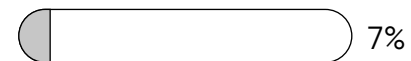

plastic / plastik / Plastik



en:
Material composition

Percentage share, by weight, of a given raw material in the Fora 421.

pl:
Skład materiałowy

Procentowy udział masy danego surowca w sofie Fotelu Fora FR 421.

de:
Materialzusammensetzung

Gewichtsprozentatz eines bestimmten Rohstoffs in der Fora FR 421.

Bejot sp. z o.o.

Wybickiego 2A, Manieczki, 63-112 Brodnica n. Poznań, POLAND

tel.: +48 (61) 281 22 25

www.bejot.eu