

W e l c o m e

reception
counters





eMeL
5-19



Sinto
44-53



VeRo
20-31



Nivero
54-63



Axer
32-43



Accessories
64-65



eMeL

reception desk

PL | Lada recepcyjna jest wizytówką biura. Dzięki naszym projektom powstają wnętrza reprezentacyjne, będące idealnym miejscem powitania gości. Stylowe i funkcjonalne lada eMeL odpowiadają na wszystkie potrzeby współczesnego biura, gwarantując pozytywny wizerunek i poczucie gościnności. Indywidualny charakter naszych lad tworzymy dzięki bogactwu kolorystyki, różnorodności kształtów i dostępnych wykończeń. Dzięki temu lada eMeL przyciągają wzrok.

EN | Reception counter is like a business card of every company. It gives the first impression. Thanks to our progressive designs, we help you create interiors that 'wow' your customers. eMeL counters are a perfect addition to places that welcome guests. They are elegant and functional. Individual character of our products is achievable because of almost unlimited range of colours, shapes and finish details that are available. It all makes eMeL counters attract. Especially looks.

DE | Die Rezeption ist eine Visitenkarte des Büros. Repräsentative Innenräume entstehen dank unserer Entwürfe. Sie sind der perfekte Ort, um Gäste zu begrüßen. Stilvolle und funktionale eMeL-Theken, erfüllen alle Anforderungen eines modernen Büros und garantieren ein positives Image und ein Gefühl der Gastfreundschaft. Wir schaffen den individuellen Charakter unserer Theken dank der Farbvielfalt, der Formenvielfalt und der verfügbaren Oberflächen. Dank dessen sind eMeL-Theken auffällig und beeindruckend.



eMeL 5



H = 1052 mm

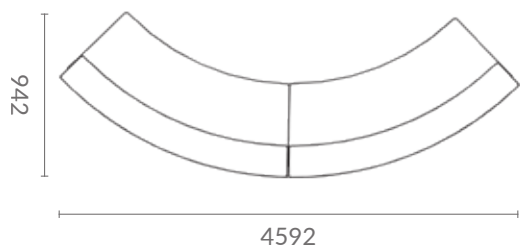





eMeL 2

H = 1052 mm

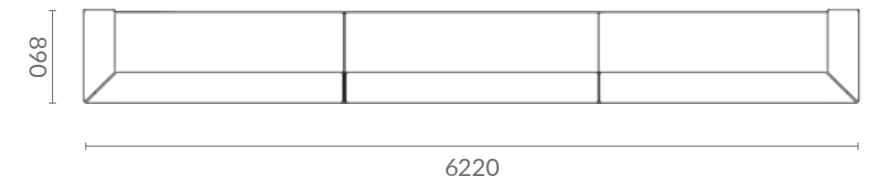
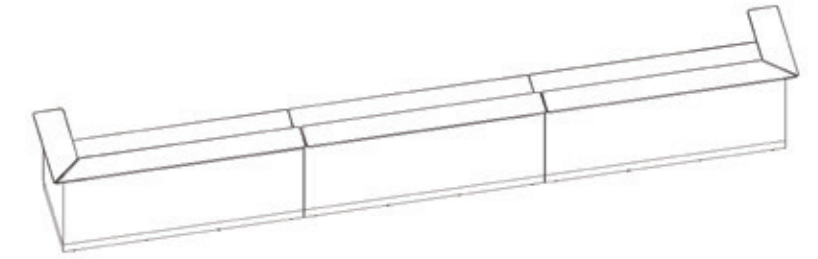



The most beautiful expectations

The exceeded ones

eMeL 3

H = 1052 mm

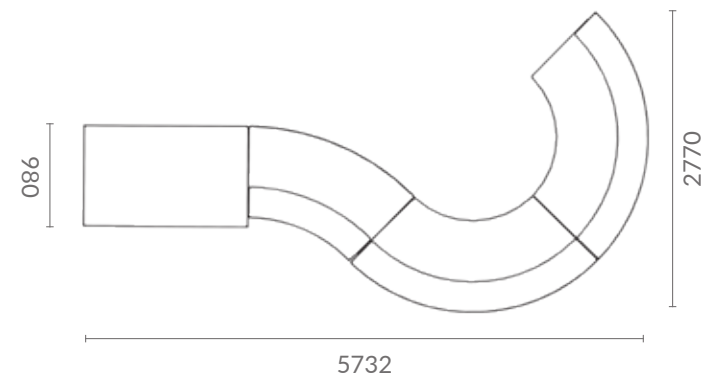
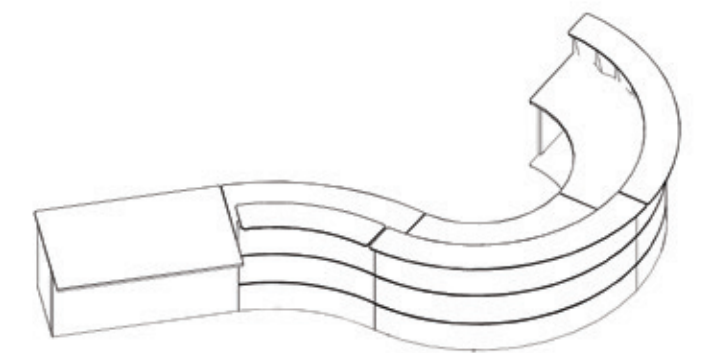

eMeL 4

H = 1052 mm

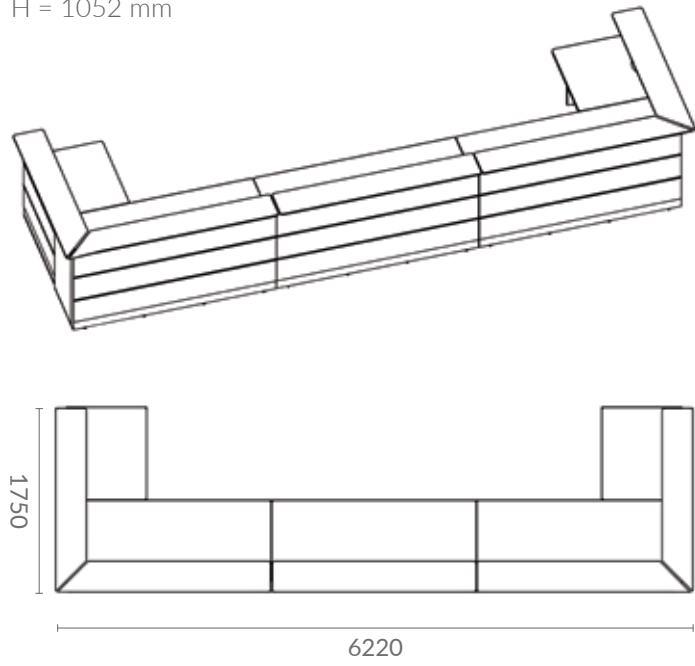

eMeL

reception desk

Wymiary
Dimensions / Größe *

Przykładowe konfiguracje
Sample configurations / Beispielkonfigurationen *

eMeL 1

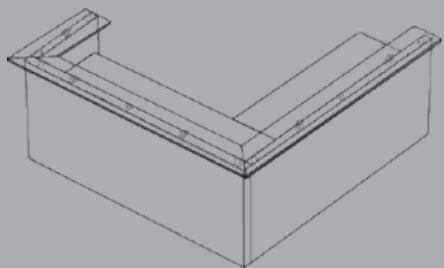

eMeL 2

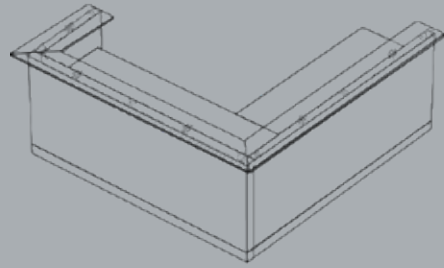

eMeL 3

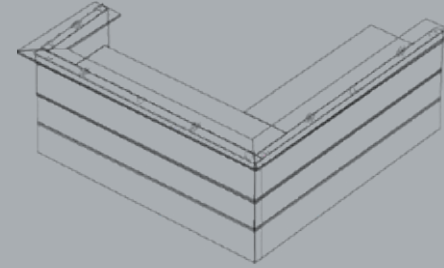

eMeL 4

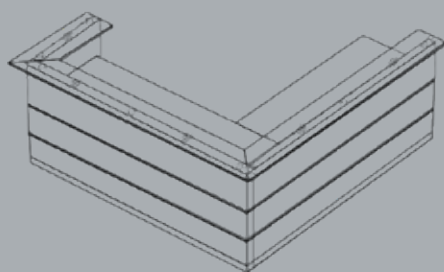

eMeL 5

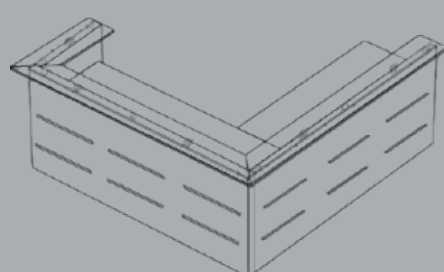

eMeL 5

Fronty podświetlane
Dostępne białe / wielokolorowe podświetlenie

Illuminated fronts
Available white / multicolor illumination

Fronte mit LED Beleuchtung
Verfügbare weiße / farbenreich Beleuchtung

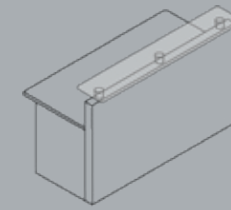

800 x 780
1200 x 780
1600 x 780
2000 x 780
2400 x 780

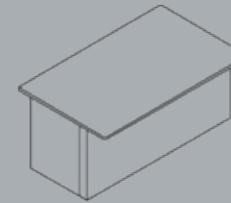

800 x 980
1200 x 980
1600 x 980
2000 x 980
2400 x 980

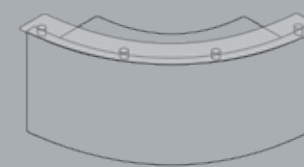

1168 (2263) x 700 (1014)

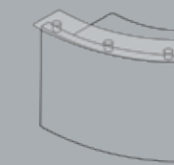

627 (1380) x 980 (1032)

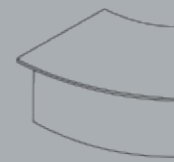

627 (1224) x 840



1702 (2296) x 942

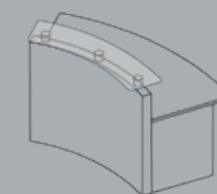

1163 (1762) x 896

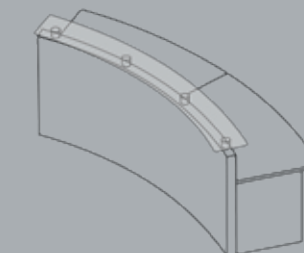

2235 (2816) x 1020

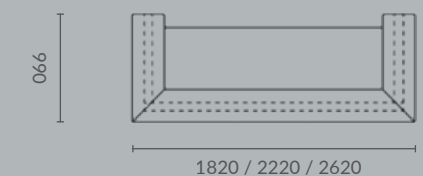
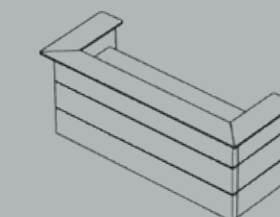
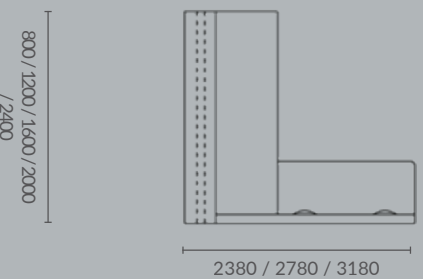
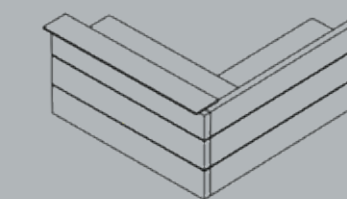
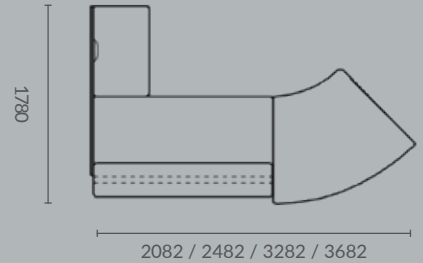
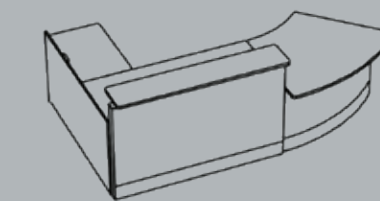
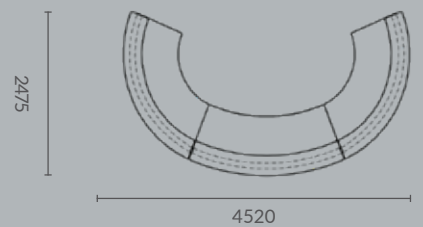
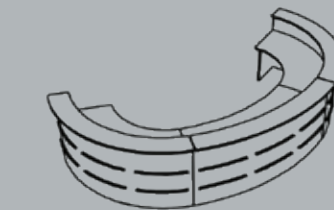
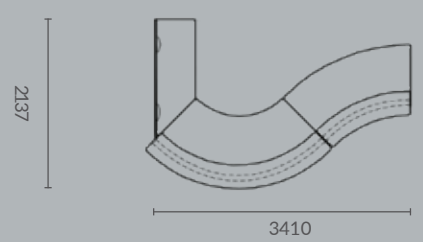
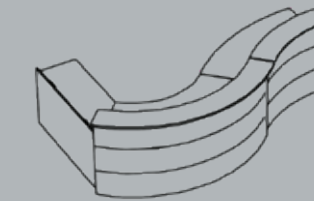
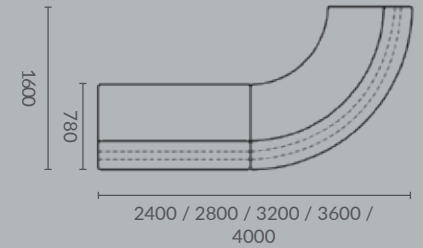
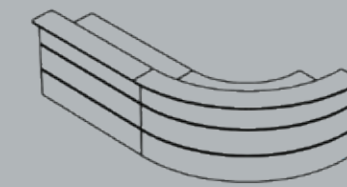

* nie dotyczy eMeL 5 / not applicable to eMeL 5 / nicht zutreffend eMeL 5



VeRo

reception desk

PL | Lady VeRo tworzą lekką formę, imponującą najwyższą jakością zarówno materiałów, jak i końcowego produktu. Dodatkowe zastosowanie światła LED podkreśla jego styl i elegancję. Nie ograniczamy się do pojedynczych dekorów lecz sięgamy po różnorodne, niejednokrotnie odważne zestawienia. Łączymy zarówno barwy, jak i faktury – dowolnie konfigurując ladę pojedynczą, ale również wieloelementowe, rozbudowane recepcje. Gwarantujemy w ten sposób wiele możliwości zaaranżowania pomieszczeń, jednocześnie dopasowując się do ich charakteru.

EN | VeRo reception counters are characterized by simplicity, high quality and timeless aesthetics. This combination creates form that is light, yet impressive. Optional LED illumination emphasizes style and elegance. We do not confine ourselves to single decors, but we are reaching for varied, sometimes brave combinations. VeRo allows to combine several colors of different parts of the furniture, in order to match your taste. Due to this fact, every piece is unique. Just like your business.

DE | VeRo-Theken zeichnen sich durch Einfachheit und hohe Ästhetik aus. Diese Kombination bildet eine leichte Form, die jedoch beeindruckt mit höchster Qualität aus beiden Materialien und dem Endprodukt. und die zusätzliche Verwendung von LED-Licht unterstreichen den Stil und die Eleganz. Wir beschränken uns nicht auf einzelne Dekore, sondern greifen zu verschiedenen, oft gewagten Kombinationen. Wir vereinigen Farben und Texturen - frei konfigurierbar für eine einzelne Theke, aber auch für mehrelementige, erweiterte Empfangstheken. Auf diese Weise garantieren wir viele Möglichkeiten der Raumgestaltung, bei gleichzeitiger Anpassung an deren Charakter.





*We have put in
the very best
Bring it out*



VeRo 4

H = 1100 mm

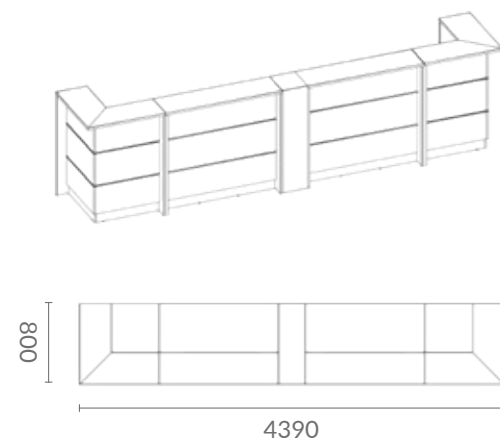

VeRo 5

H = 1100 mm

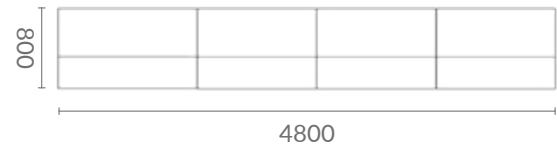
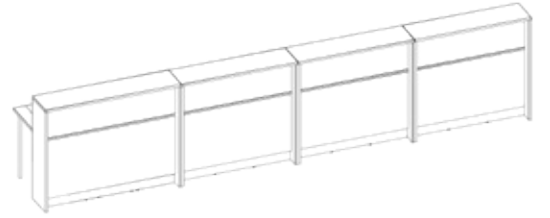

VeRo 5

H = 1100 mm

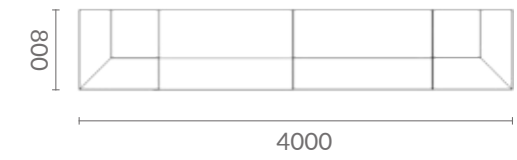
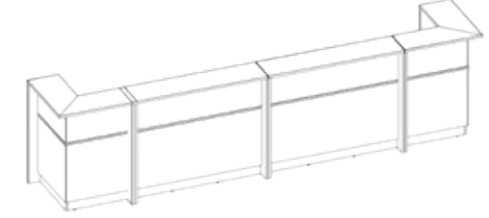



VeRo 6

H = 1100 mm

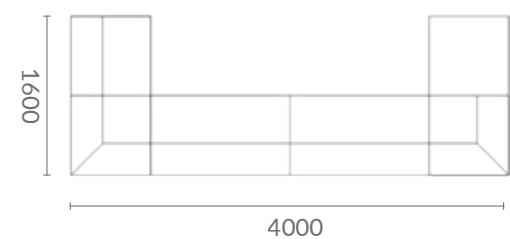
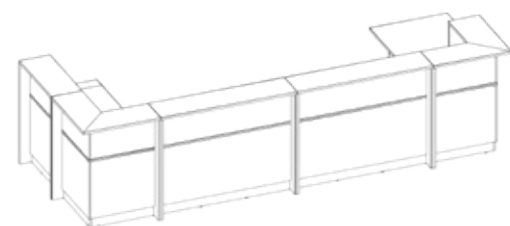

*Extraordinary
appearance*

VeRo

reception desk

Wymiary
Dimensions /Größe

Przykładowe konfiguracje
Sample configurations /Beispielkonfigurationen

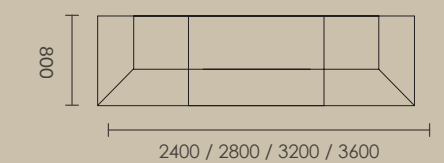
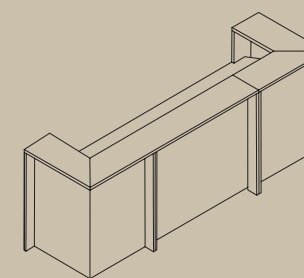
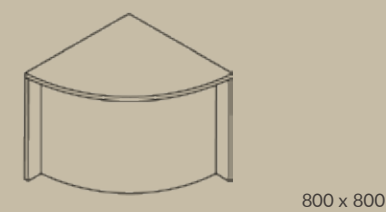
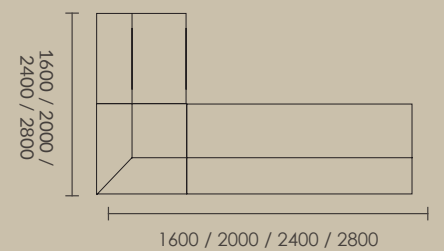
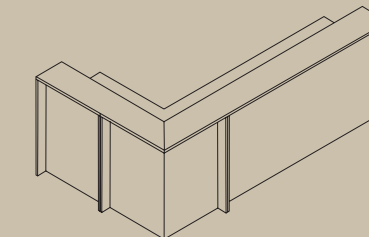
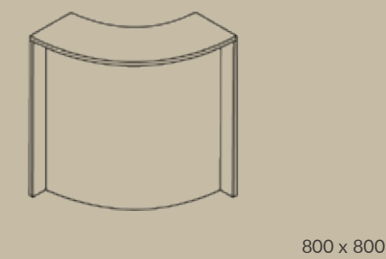
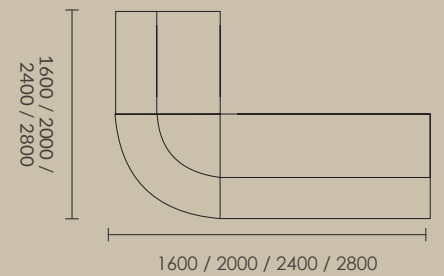
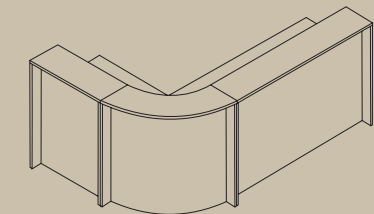
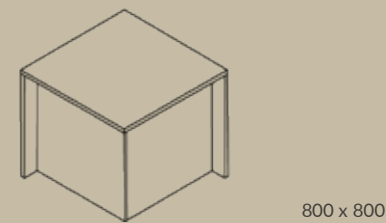
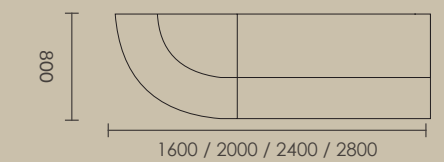
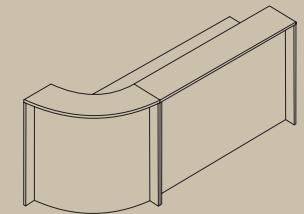
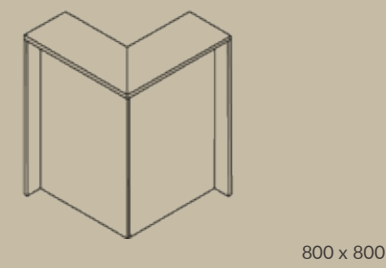
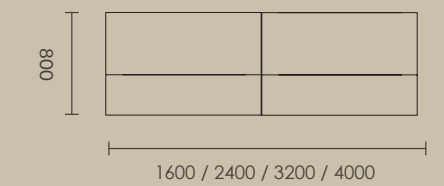
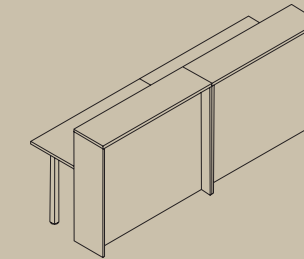
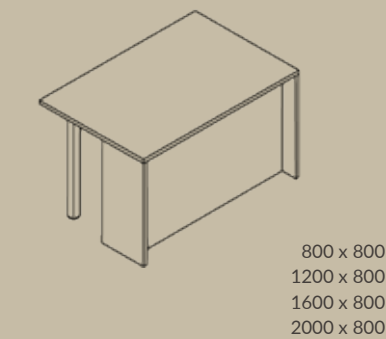
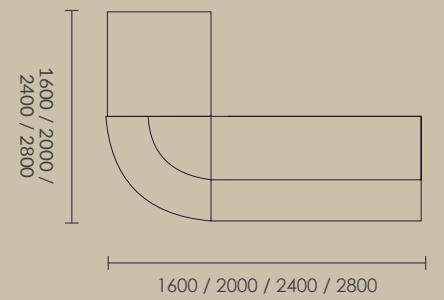
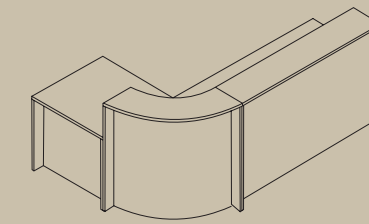
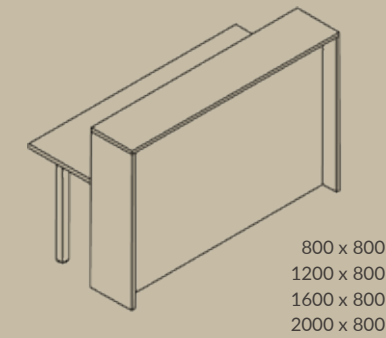

VeRo 1

VeRo 2

VeRo 3

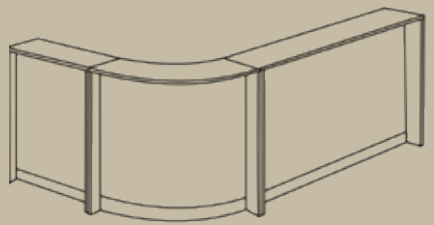
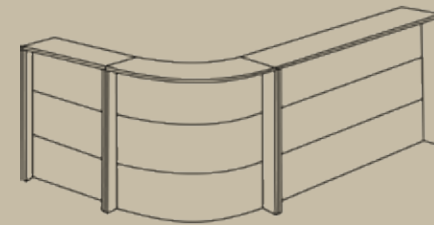
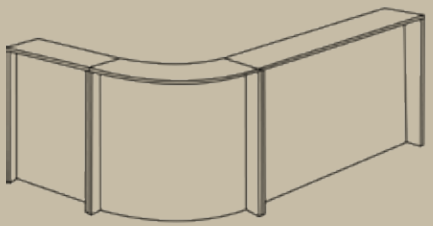
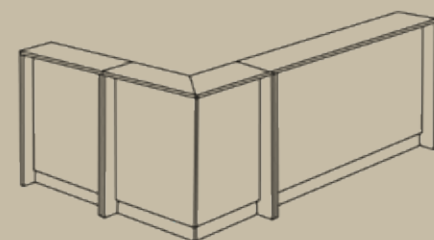
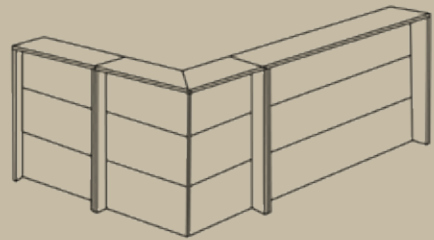
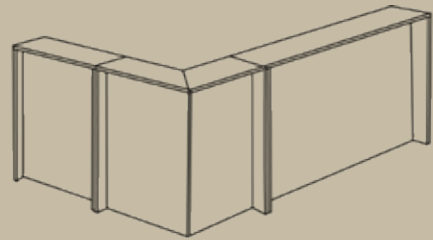

VeRo 4

VeRo 5

VeRo 6

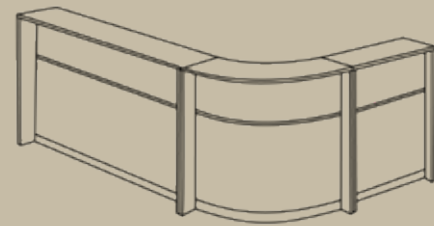
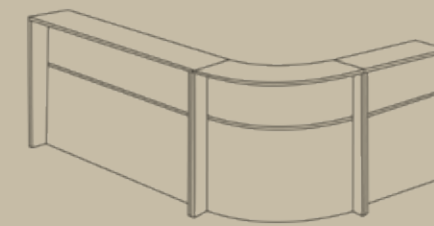
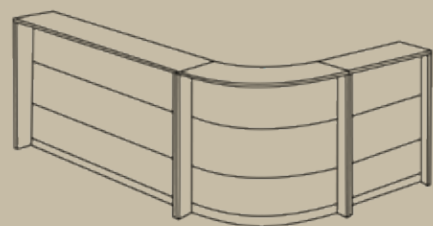
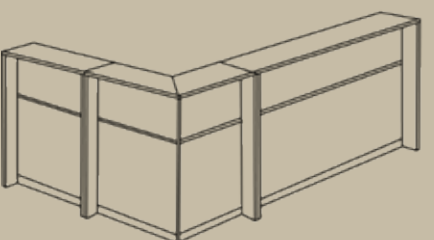
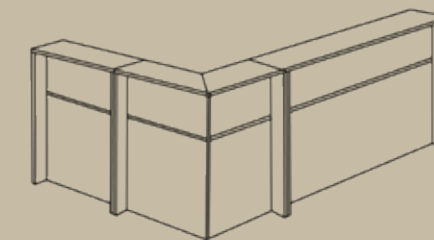
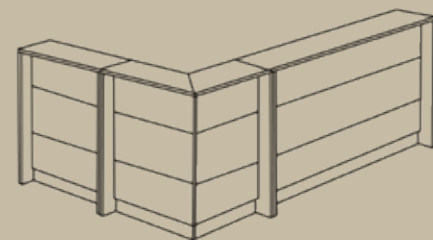

Axer

reception desk

PL | Lady Axer tworzą przestrzenie niepowtarzalne oraz nowoczesne w swojej prostocie. Subtelny napis ze stali polerowanej podkreśla elegancję wnętrza oraz pokazuje wyraźny komunikat, gwarantując w ten sposób atmosferę gościnności i pozytywny odbiór biura. Możliwość dobrania nadstawki, to elastyczne rozwiązanie, które oferuje szeroki zakres konfiguracji produktu, zarówno pod względem jej montażu jak również wyboru dekorów. Lada mimo swojej prostoty idealnie spełnia wszystkie funkcjonalne potrzeby, a jej geometryczna forma i minimalizm są doskonałym wykończeniem wnętrza.

EN | Axer reception counters help to create modern and unique interiors. Subtle inscription made from polished steel emphasizes elegance of the piece and gives clear statement. At the same time, it guarantees welcoming atmosphere and positive perception of the office. Two different worktops to choose from, allow several different configurations, making it also an element contrasting with the rest of the furniture. Even though Axer is simple in design, it meets all functional needs of even most demanding users. It's geometric and minimalistic form is a perfect highlight of every space.

DE | Die Axer-Theken bilden moderne und einzigartige Räume. Die feine Inschrift aus poliertem Stahl unterstreicht die Eleganz des Innenraums und gibt eine klare Botschaft ab, wodurch die Atmosphäre der Gastfreundschaft und der positiven Rezeption des Büros garantiert wird. Die Möglichkeit, einen Ausfatz auszuwählen, ist eine flexible Lösung, die eine breite Palette an Produktkonfigurationen und -personalisierungen bietet, sowohl in Bezug auf die Montage als auch in Bezug auf die Auswahl der Dekore. Trotz die Formeinfachheit, erfüllt diese Theke perfekt alle funktionalen Anforderungen, und seine geometrische Form und Minimalismus sind die perfekte Bekrönung des Innenraums.





Axer U

H = 1050

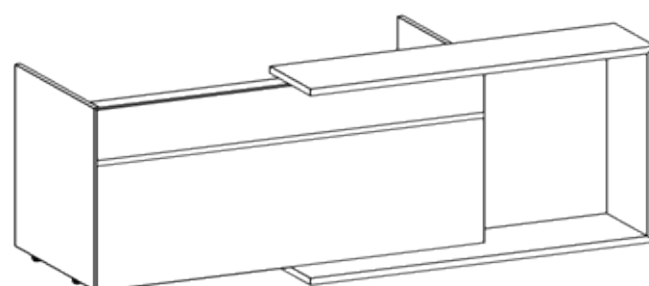
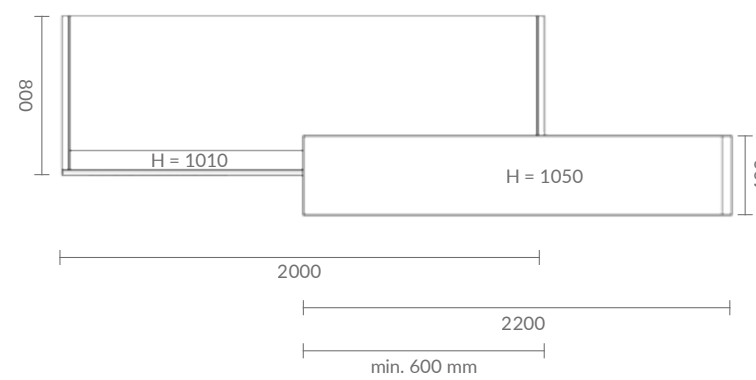

Axer

Axer

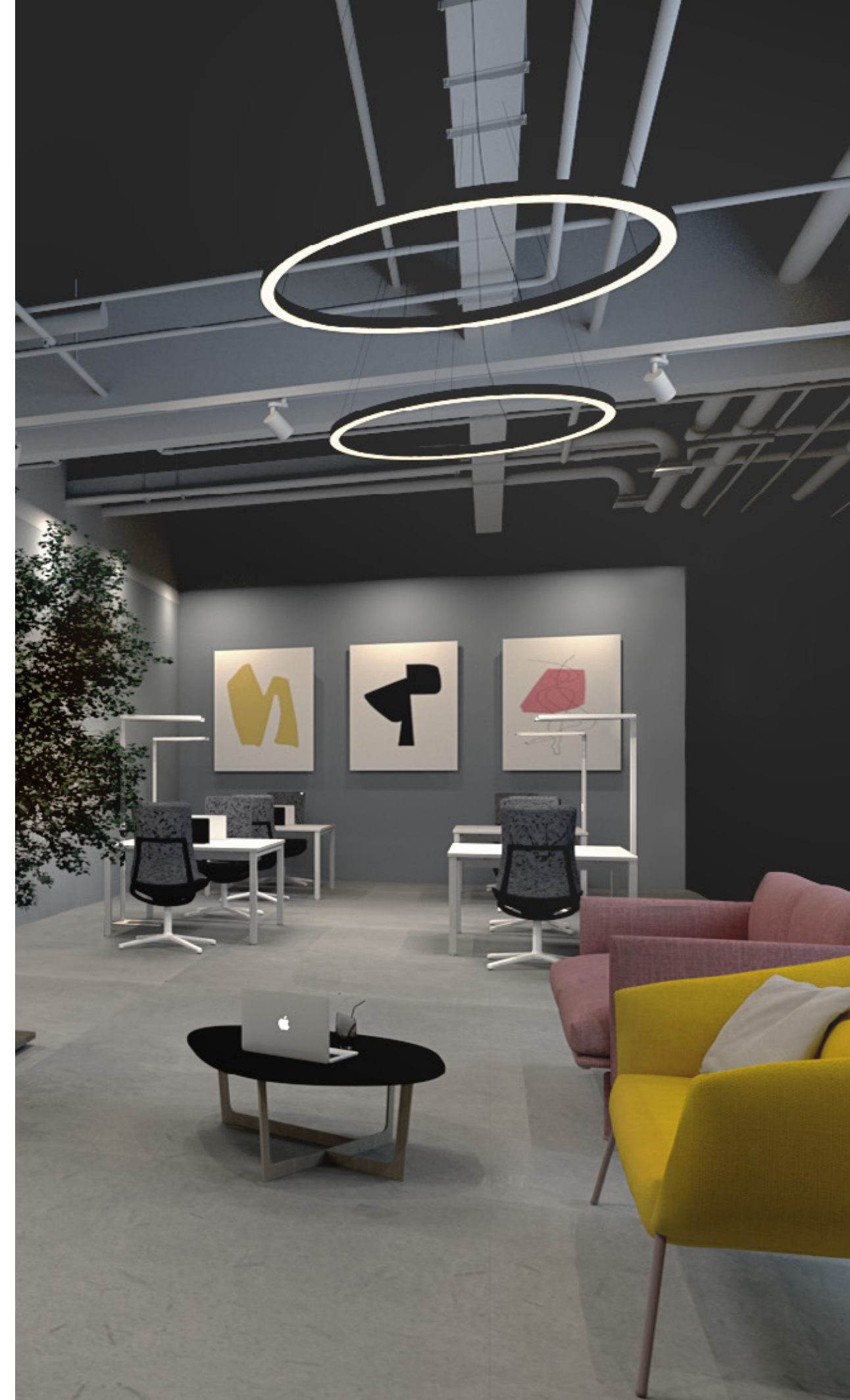

Axer 2x U

H = 1050

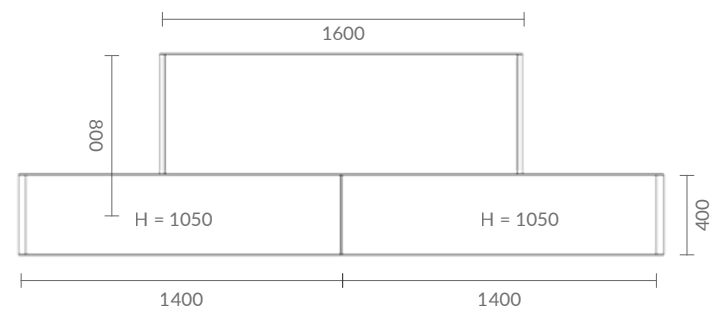
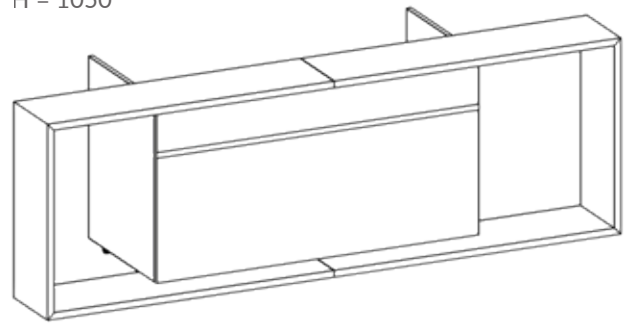



Axer 2x L

H = 1050

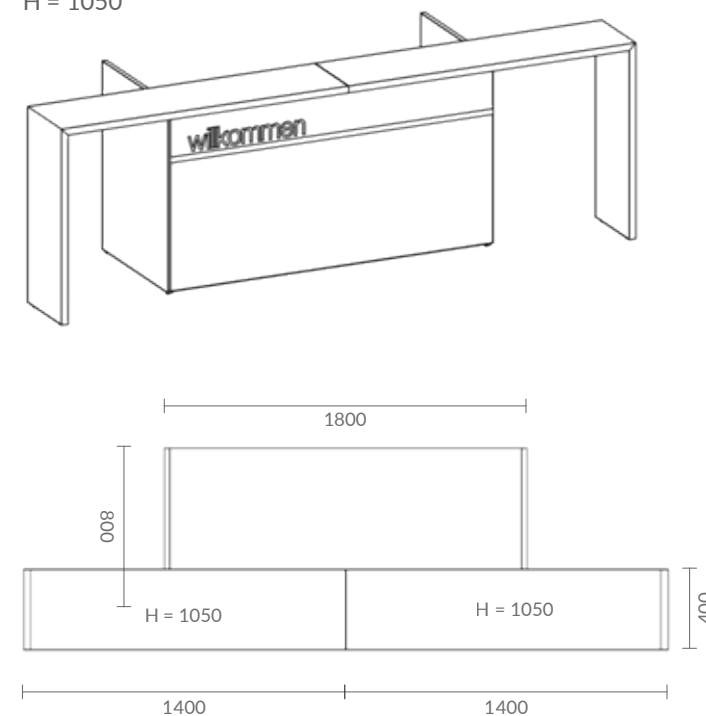

Axer

reception desk

Axer 2xU

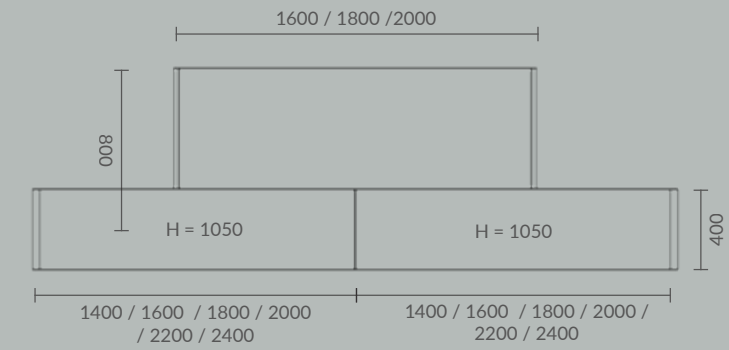
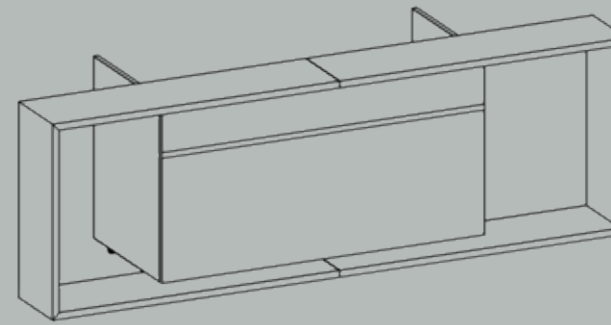

Axer L

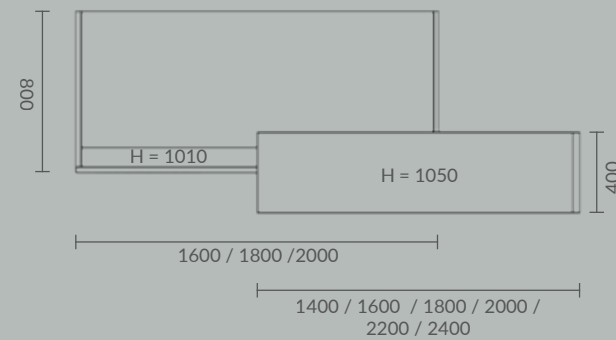
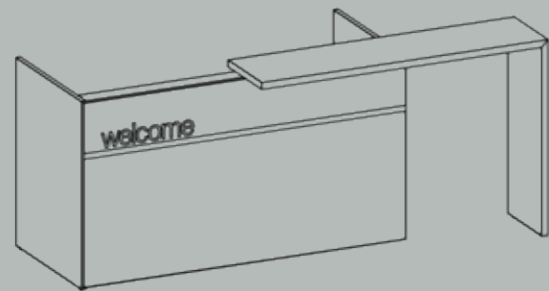

Axer 2xL

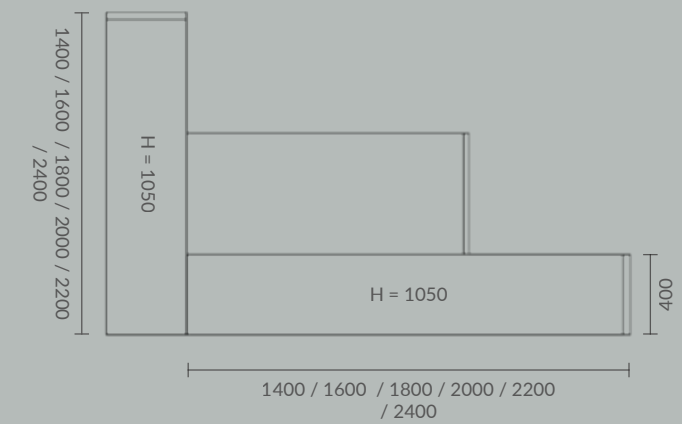
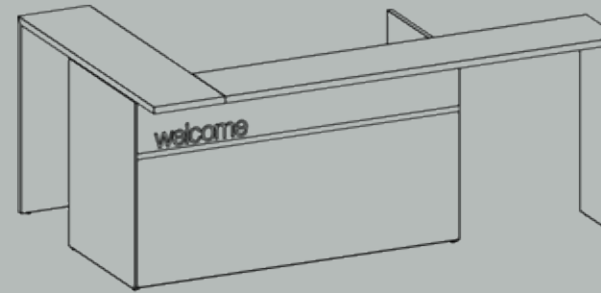

Axer U

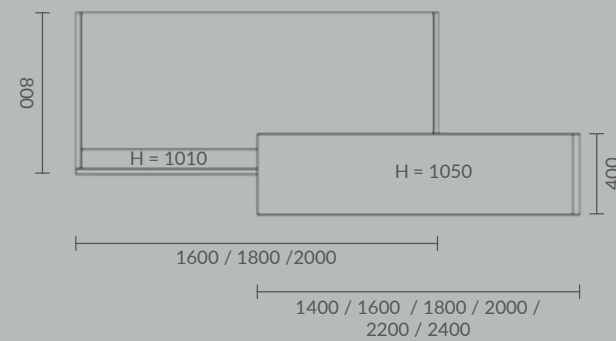
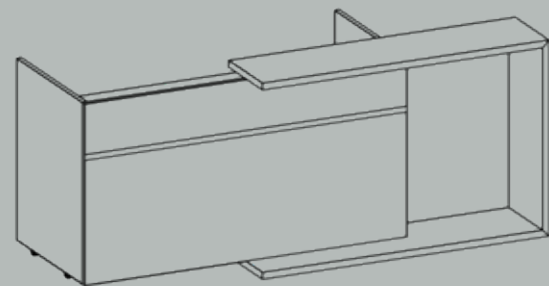

Elements

U Type

H = 1050

1400 x 400
1600 x 400
1800 x 400
2000 x 400
2200 x 400
2400 x 400

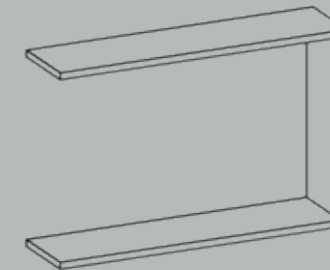

H = 1010

1600 x 800
1800 x 800
2000 x 800

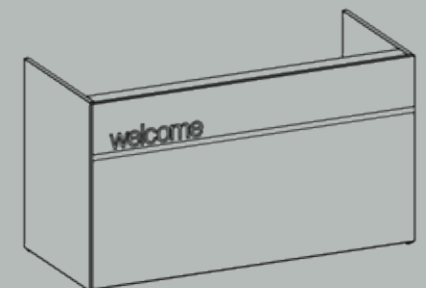

Axer 2xL

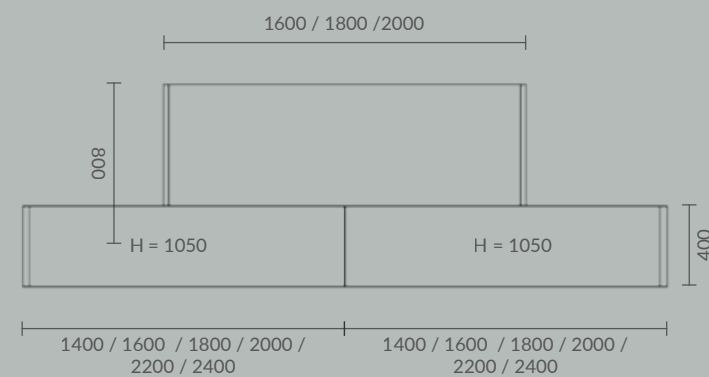
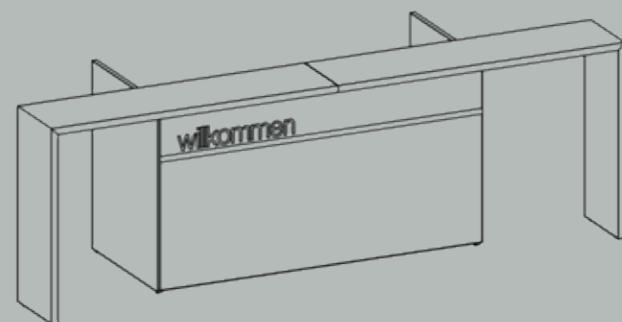

L Type

H = 1050

1400 x 400
1600 x 400
1800 x 400
2000 x 400
2200 x 400
2400 x 400

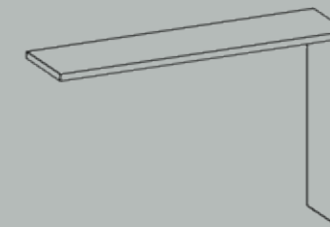

H = 1010

1600 x 800
1800 x 800
2000 x 800

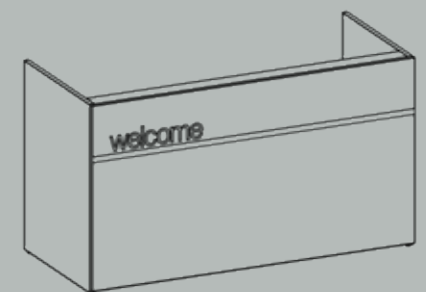

Sinto

reception desk

PL | Projektując ladę recepcyjną Sinto, nasz zespół projektowy stawiał nacisk na reprezentacyjność i uniwersalność formy. Charakteryzuje się ona przede wszystkim mocnymi geometrycznymi kształtami, które zostaną zauważone w każdym wnętrzu. Front lady intryguje nie tylko dzięki wykorzystaniu wysokiej klasy materiałów, ale również przez możliwość zastosowania światła LED. Dzięki kompaktowym wymiarom, lada Sinto doskonale prezentuje się zarówno w dużych, jak i mniejszych przestrzeniach.

EN | When designing Sinto, our design team was focused on representativeness and monumentalism of its form. It is characterized by strong geometric shapes, that attract looks and add character to interior. It all makes product that can meet expectations of even the most demanding users. Front of the counter surprises not only by high quality materials, but also by addition of subtle light. Compact dimensions make it possible to fit Sinto into both spacious, as well as smaller interiors.

DE | Bei der Gestaltung der Sinto-Theken, hat unser Designteam Wert auf Repräsentativität und Monumentalität der Form gelegt. Es zeichnet sich vor allem durch starke geometrische Formen aus, die dem Innenraum Charakter verleihen und nicht unbemerkt bleiben. Die Vorderseite der Theke fasziniert nicht nur durch die Verwendung hochwertiger Materialien, sondern auch durch die Verwendung von LED-Licht. Dank seiner kompakten Abmessungen präsentiert sich der Sinto-Theke sowohl auf großen als auch auf kleinen Flächen perfekt.





Sinto

H = 1100

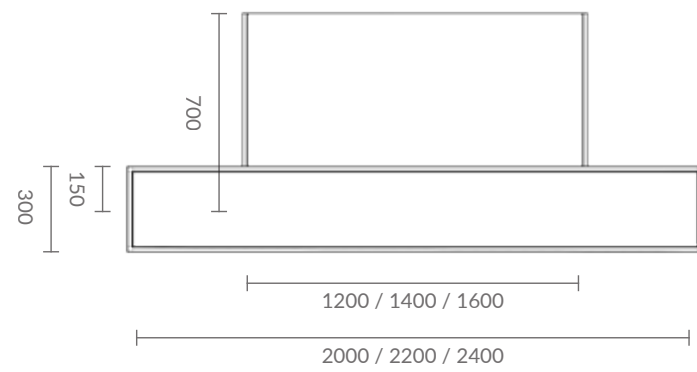
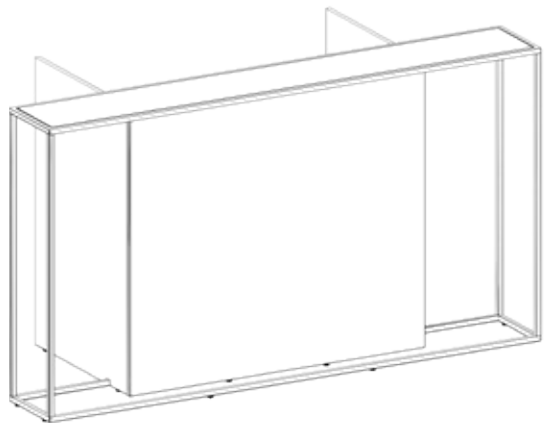



Sinto
reception desk

*It attracts.
Especially looks.*

Sinto

reception desk

Wymiary / Dimensions / Größe

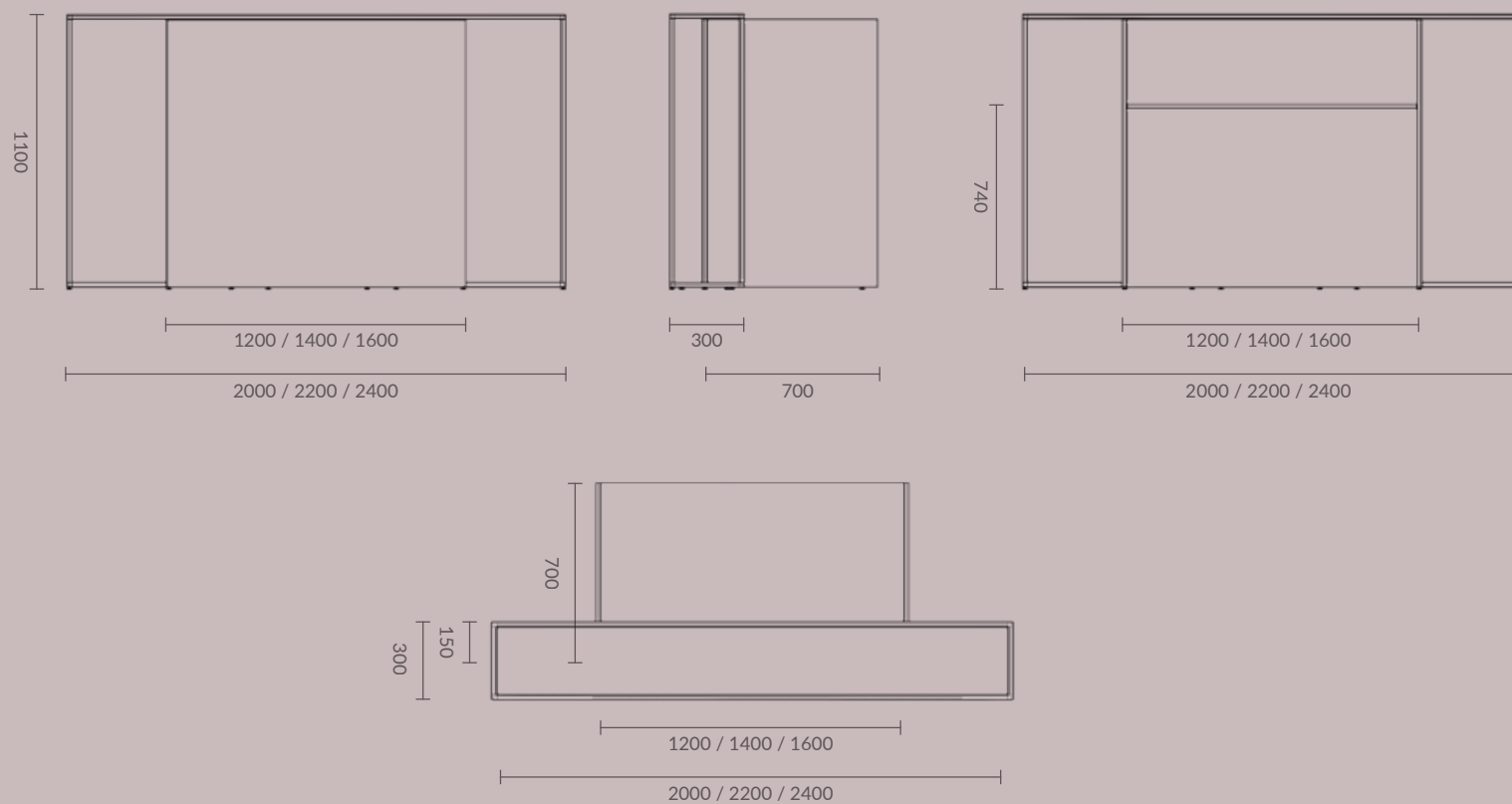

Model / Model / Modelle

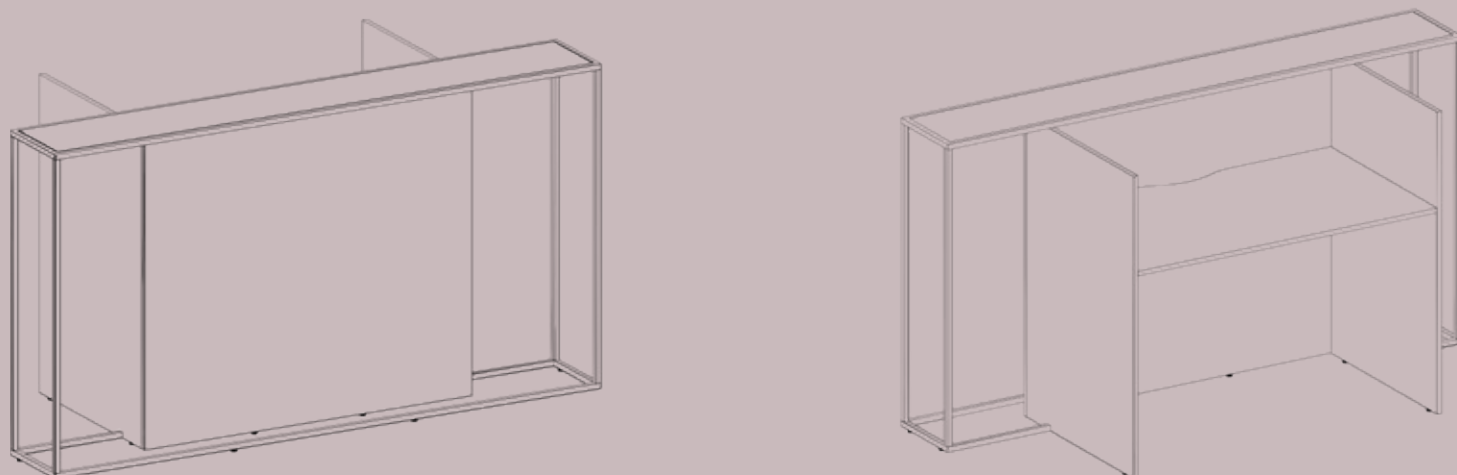



Nivero

reception desk

PL | Lada Nivero to projekt łączący w sobie funkcjonalność i nowoczesny design. Dzięki swojej geometrycznej formie oraz podwyższonej centralnej części frontu, przyciąga wzrok i podkreśla przestrzeń o zarówno nowoczesnej, jak i klasycznej architekturze. Uniwersalny kształt, wysokiej klasy materiały w połączeniu z możliwością subtelnego zastosowania światła LED, wskazują na prestiż i wysoką jakość mebla. Dzięki kompaktowym wymiarom, lada Nivero doskonale prezentuje się zarówno w dużych jak i mniejszych przestrzeniach.

EN | Nivero reception counter is a project that combines functionality and modern design. Because of its geometric form and raised central part of the front, our reception counter is eye-catching and emphasizes interiors with both modern and classic architecture. Universal shape, high-end materials combined with the possibility of subtle use of LED illumination indicate the prestige and superior quality of the furniture. Compact dimensions of Nivero make it possible to fit perfectly into both spacious, as well as smaller spaces.

DE | Die Nivero Theke vereint Funktionalität und modernes Design. Dank ihrer geometrischen Form und der höheren Empfangsablage in der Frontmitte fesselt sie die Aufmerksamkeit und betont sowohl moderne als auch klassische Innenräume. Universelles Design, hochwertige Materialien, eine zarte LED-Beleuchtung bürgen für eine hohe Produktqualität. Die kompakte Form der Nivero Theke macht einen perfekten Eindruck sowohl in großen als auch in kleineren Räumen.





Nivero

H = 1265

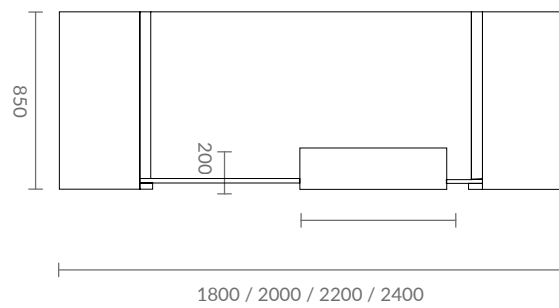
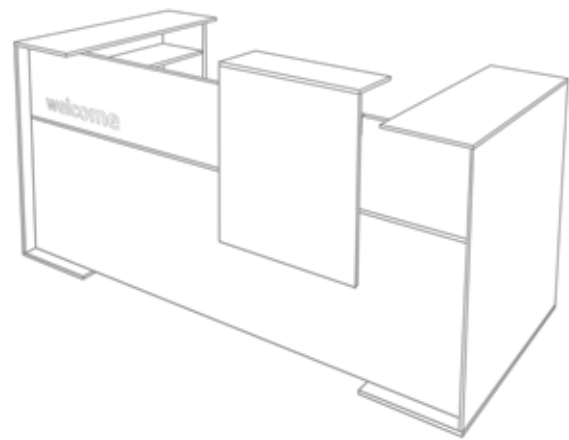



Spacious place.

To save your ideas.



Nivero

reception desk

Wymiary / Dimensions / Größe

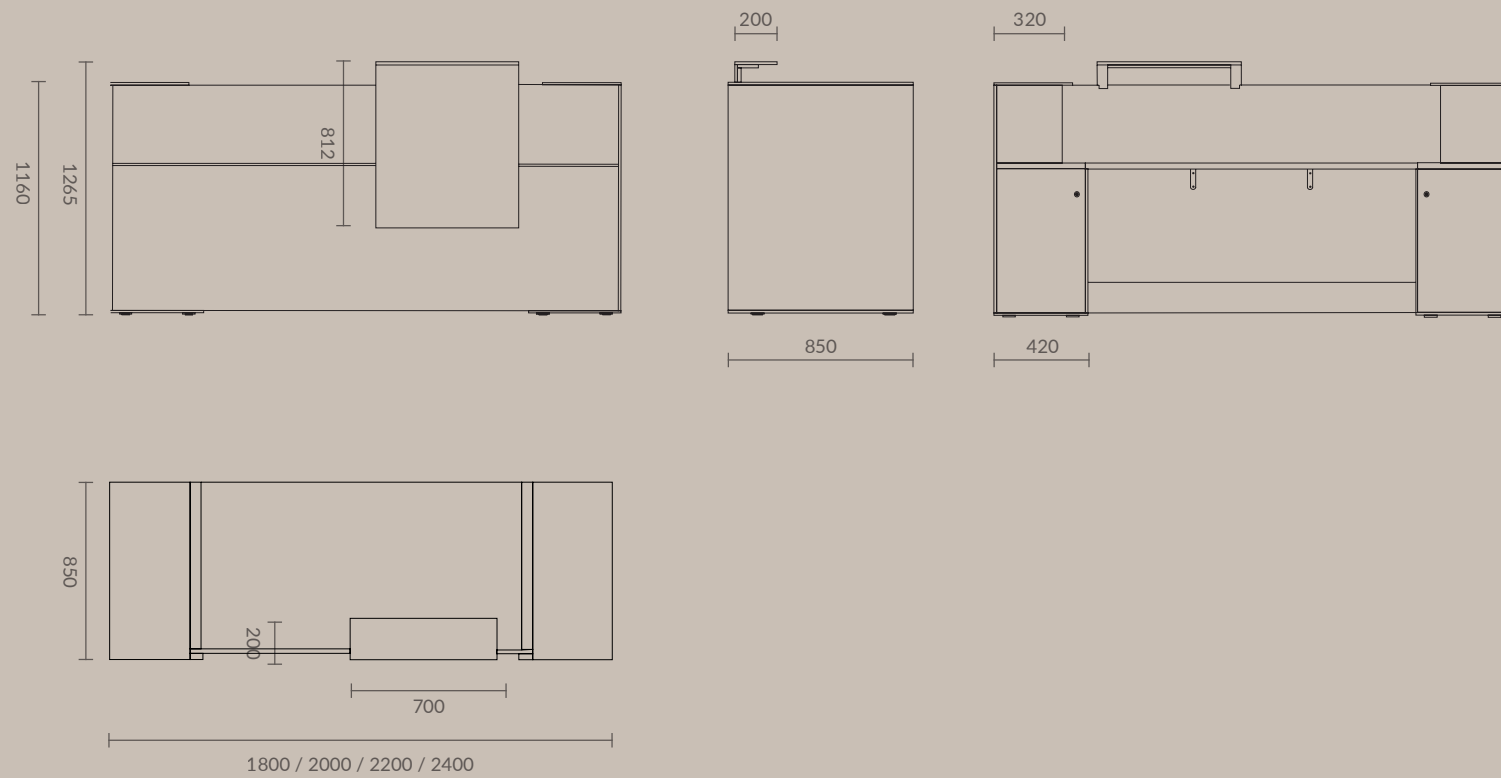

Model / Model / Modelle

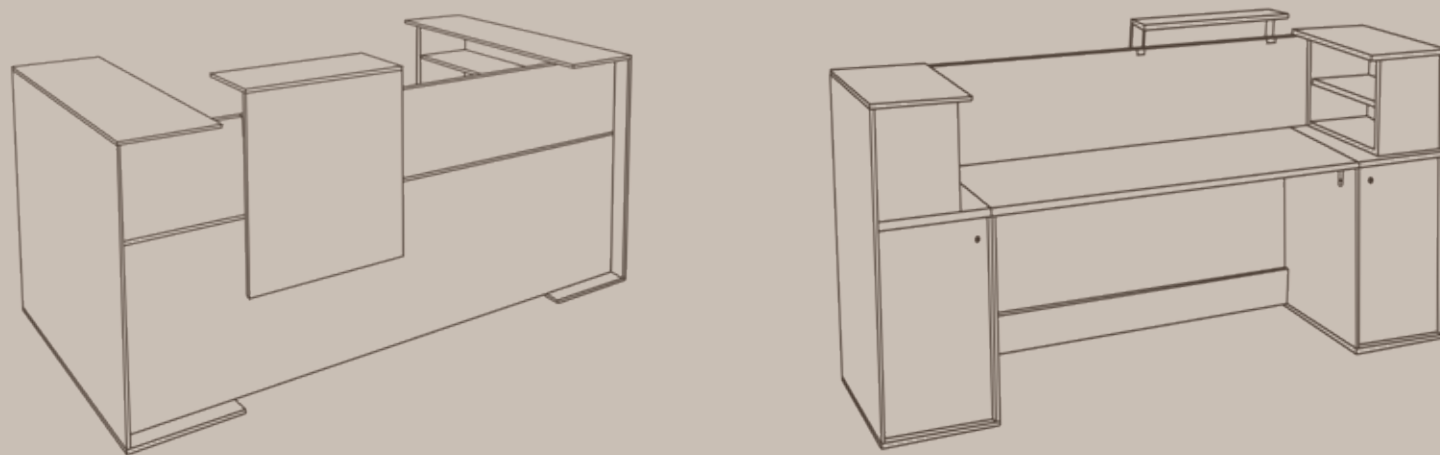

Akcesoria / Accessories / Zubehör

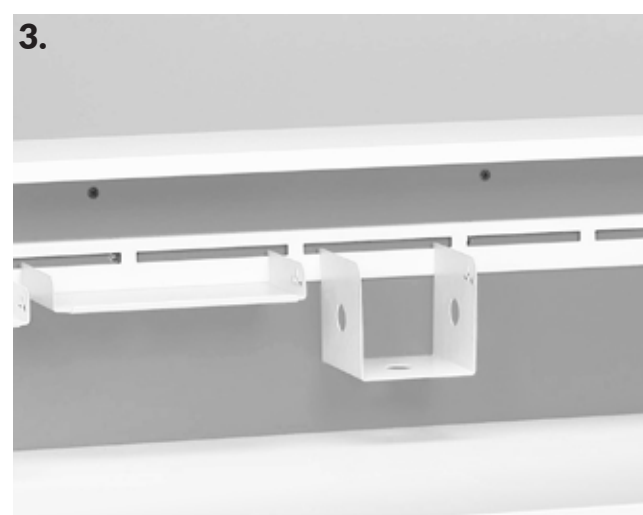
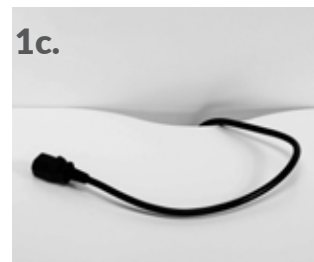

	eMeL	VeRo	Axer	Sinto	Nivero
1a. Przelotka / Cable outlet / Kabelbuchse					●
1b. Przelotka narożnikowa/ Corner cable outlet / Ergonomische Ausfräsung für Kabel		●			
1c. Przelotka ergonomiczna / Ergonomic cable outlet / Kabelauslässe	●		●	●	
2. Półka pod monitor / Monitor shelf / Ausschnitt für Bildschirm		●	●	●	●
3. Listwa metalowa / Metal accessories rail / Organisationleiste		●	●	●	
4. Szafka z drzwiami skrzydłowymi / Cabinet with hinged doors / Schrank mit Flügeltüre		●			

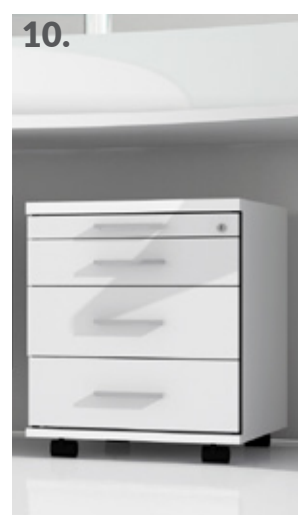

	eMeL	VeRo	Axer	Sinto	Nivero
5. MARO Power Circle	●	●	●	●	●
6. Szuflada podbiurkowa / Desk drawer / Schublade unter dem Schreibtisch	●	●	●	●	
7. Noga niezależna do wsparcia blatu / Metal leg / Metallfuß	●	●			
8. Kanał kablowy pionowy / Vertical cable channel / Vertikaler Kabelkanal	●	●	●	●	●
9. Kontener NANO / NANO pedestal / NANO Container	●	●	●	●	
10. Kontener podbiurkowy TOP / Under desk TOP pedestal / Untertisch TOP Container	●	●	●		



Fabryka Mebli Biurowych MARO Sp. z o.o.
PL 62-052 Komorniki, ul. Fabianowska 100
T +48 61 890 00 00 F +48 890 00 90
E maro@maro.pl www.maro.pl

www.maro.pl

Niniejsza publikacja nie stanowi oferty w rozumieniu prawnym. MARO zastrzega sobie prawo wprowadzania zmian w oferowanych meblach. Prezentowane kolory mogą odbiegać od rzeczywistości.
This publication does not constitute a legally binding offer. MARO reserves the right to change product specifications at any time without a prior notice. Colors presented in this publication may vary from the actual ones.
Die unten aufgeführte Publikation ist nicht ein Angebot im rechtlichen Sinne. MARO behält sich das Recht vor, den Produktangebot zu verändern, jeder Zeit gegen ihrer endgültigen Entscheidung, auch ohne früherer Ankündigung. Die auf den Abbildungen zu ersene Farbkoloristik kann von der originalen Färbung abweichen.

Wszystkie wzory chornione są w Urzędzie Patentowym RP