

Ario

demand more

MARO



Ario

Kolekcja Ario oferuje bogatą stylistykę, łącząc ze sobą bogactwo szlachetnych materiałów, niedoścignione wykonanie i ergonomię użytkowania. Ekskluzywna gama nieoczywistych komponentów, pozwala na nadanie wnętrzu indywidualnego charakteru oraz spersonalizowania według własnych potrzeb. Ario rozpieści użytkowników elegancją, dbałością o szczegóły oraz innowacjami.

Ario – dla tych, co oczekują więcej.

Ario offers unmet style, combining exquisite materials, finest craftsmanship and ergonomics. An exclusive range of components allows you to give the interior an individual character and personalize it according to your needs. Ario spoils users with elegance, attention to detail and innovation.

Ario – for those who demand more.





Ario

demand more

Polerowane kamienne i skórzane wykończenia nadadzą powagi wnętrzu. Innowacyjna szafka ze zintegrowanym, elektrycznie chowanym barkiem to idealne uzupełnienie przestrzeni gabinetowej lub konferencyjnej.

Stone and leather finishes will add noble character to every interior. Innovative cabinet with integrated, electrically operated mini-bar is a perfect conference space.

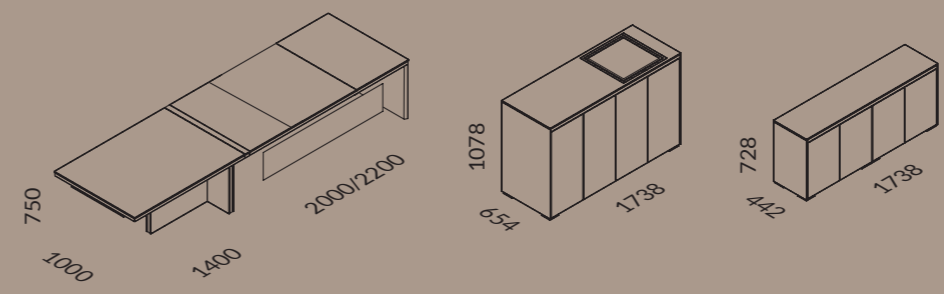

- | | | | |
|---|---|---|--|
|  | ST2
Kamień polerowany
NOIR DESIR
Polished stone
NOIR DESIR |  | Szko
CZARNE LACOBEL
Glass
BLACK LACOBEL |
|  | N05
Fornir
PALISANDER BRAZYLIJSKI
Veneer
BRASILIAN ROSEWOOD |  | LE3
Skóra naturalna
CZARNA
Natural leather
BLACK |
|  | U10
Melamina
BEZOWY KASZMIR
Melamine
BEIGE CASHMERE |  | Akcent
ALUMINIUM
SZCZOTKOWANE
Decorative strip
BRUSHED ALUMINIUM |





Ario

demand more

Znakomity mebel wyróżnia nie tylko unikatowy design. Wyznacznikiem jakości jest suma wszystkich specyficznych rozwiązań technicznych. Personalizowanie rozwiązania przeprowadzenia okablowania oraz zintegrowane stacje zasilania, spowodują, że prąd i media będą dostępne na wyciągnięcie ręki.

Moves the border. An excellent piece of furniture is not only distinguished by design. The determinant is the sum of all details and technical solutions. Cable management and integrated power stations available on request will make electricity and media available at your fingertip.

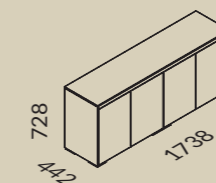
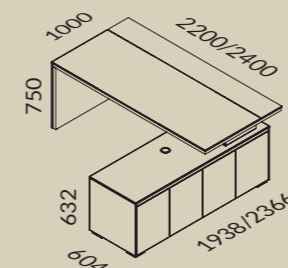

N06
Fornir
DĄB FLADER
Veneer
FLADER OAK

U1
Melamina
BIAŁY
Melamine
WHITE

Szkoło
BIAŁE LACOBEL
Glass
WHITE LACOBEL

Akcent
ALUMINIUM
SZCZOTKOWANE
Decorative strip
BRUSHED ALUMINIUM

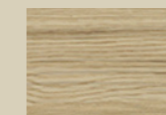
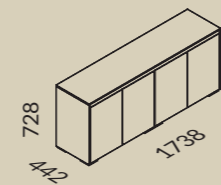
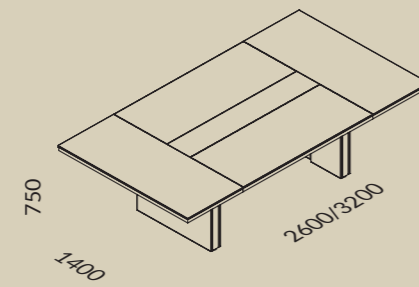
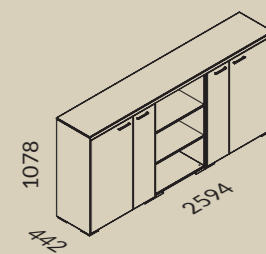

N06
Fornir
DĄB FLADER
Veneer
FLADER OAK



Szko
BIAŁE LACOBEL
Glass
WHITE LACOBEL



U1
Melamina
BIAŁY
Melamine
WHITE



Akcent
ALUMINIUM
SZCZOTKOWANE
Decorative strip
BRUSHED ALUMINIUM

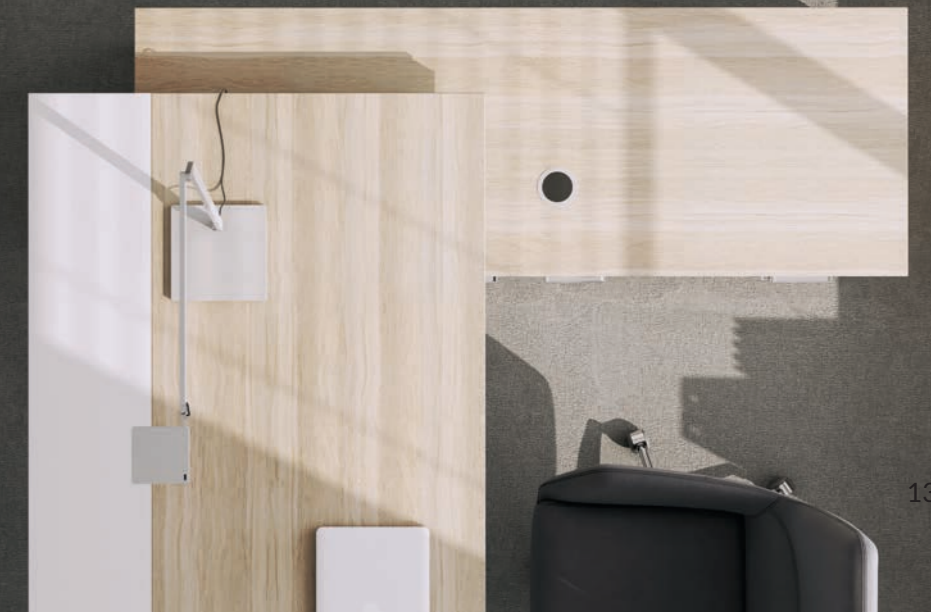









Ario

demand more

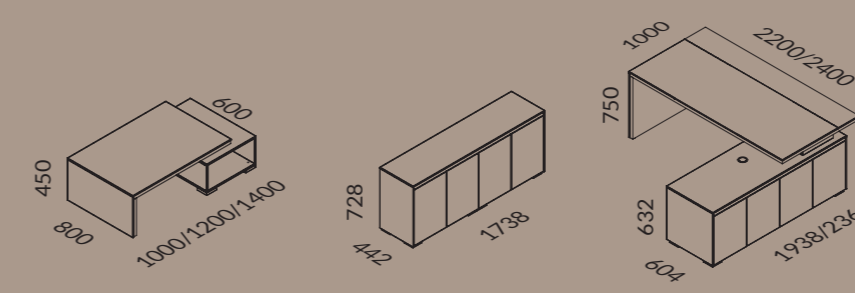
Praca wymaga zasad. Twoich. Dzięki szerokiej ofercie dostępnych modeli, możesz stworzyć różne strefy odpowiadające Twojemu charakterowi. Od pracy w skupieniu, przez miejsce do konferowania, po rozluźnione rozmowy przy kawie – Ario doskonale sprawdzi się w każdym kontekście.

Work requires rules. Your rules. Thanks to a wide array of available models, you can create different zones that best depict the character of your work. Ranging from focus work, through conference zone, to relaxed conversations with coffee – Ario will turn out to be a perfect option for every scenario.

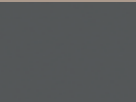

-  DR1
Melamina 3D
ORZECH MADISON
3D Melamine
WALNUT MADISON
-  U11
Melamina
GRAFIT
Melamine
GRAPHITE
-  Szko
CZARNE LACOBEL
Glass
BLACK LACOBEL
-  LE2
Skóra naturalna
GRAFITOWA
Natural leather
GRAPHITE
-  Akcent
ALUMINIUM
SZCZOTKOWANE
Decorative strip
BRUSHED ALUMINIUM

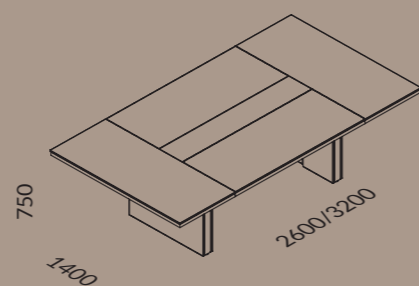

DR1
Melamina 3D
ORZECH MADISON
3D Melamine
WALNUT MADISON



LE2
Skóra naturalna
GRAFITOWA
Natural leather
GRAPHITE



U11
Melamina
GRAFIT
Melamine
GRAPHITE

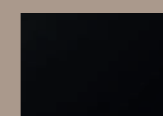

Szko
CZARNE LACOBEL
Glass
BLACK LACOBEL



Akcent
ALUMINIUM
SZCZOTKOWANE
Decorative strip
BRUSHED ALUMINIUM







Ario

demand more

Dla człowieka od zawsze naturalnym było przebywanie w ruchu. Szeroka kolekcja, na którą składają się również biurka z elektryczną regulacją wysokości to synonim ergonomii. Najwyższy komfort gwarantem najwyższej koncentracji.

Humans are meant to move. Wide collection, which also includes desks with electric height adjustment, is synonymous with ergonomics. The highest comfort guarantees the highest concentration.

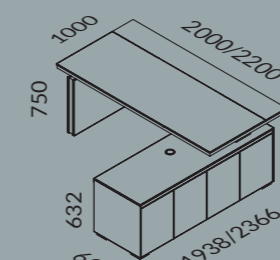
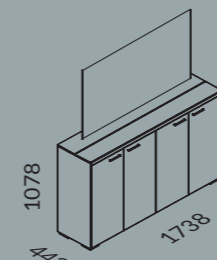
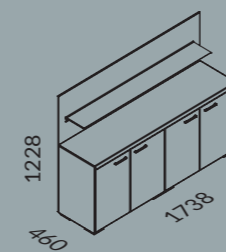

ST2
Kamień polerowany
NOIR DESIR
Polished stone
NOIR DESIR



U10
Melamina
BEZOWY KASZMIR
Melamine
BEIGE CASHMERE

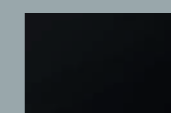

Szko
CZARNE LACOBEL
Glass
BLACK LACOBEL

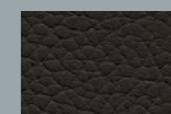

LE1
Skóra naturalna
BRĄZOWA
Natural leather
BROWN



Akcent
ALUMINIUM
SZCZOTKOWANE
Decorative strip
BRUSHED ALUMINIUM

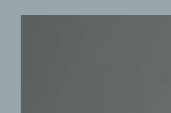

Szko
CZARNE OPTI
Glass
BLACK OPTI



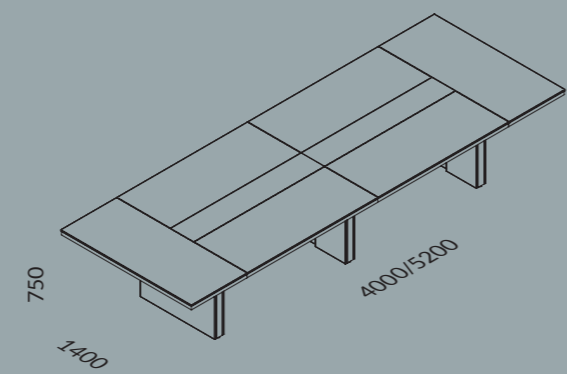

ST2
Kamień polerowany
NOIR DESIR
Polished stone
NOIR DESIR

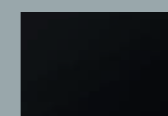

Szkoło
CZARNE LACOBEL
Glass
BLACK LACOBEL

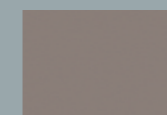

U10
Melamina
BEZOWY KASZMIR
Melamine
BEIGE CASHMERE



Akcent
ALUMINIUM
SZCZOTKOWANE
Decorative strip
BRUSHED ALUMINUM







Ario

demand more

Eleganckie, uporządkowane, pełne pięknych materiałów, czerpiących z natury – Ario to kolekcja meblowa inna niż wszystkie. Wyposażona w innowacje, poprawiające komfort codziennego użytkowania, które pozwolą stworzyć Twój azyl – w biurze i w domu.

Elegant, extraordinary, full of beautiful materials - Ario is a furniture collection unlike any other. Equipped with innovations, that rise your comfort, will help to create your asylum - in the office or at home.

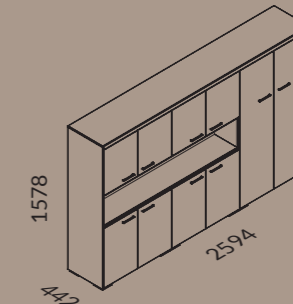
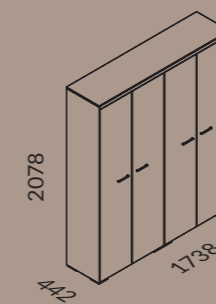
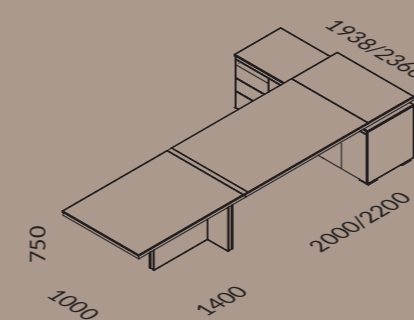

-  DR4
Melamina 3D
DĄB GÓRSKI SZARY
3D Melamine
SCANDINAVIAN OAK
-  U1
Melamina
BIAŁY
Melamine
WHITE
-  LE1
Skóra naturalna
BRAZOWA
Natural leather
BROWN

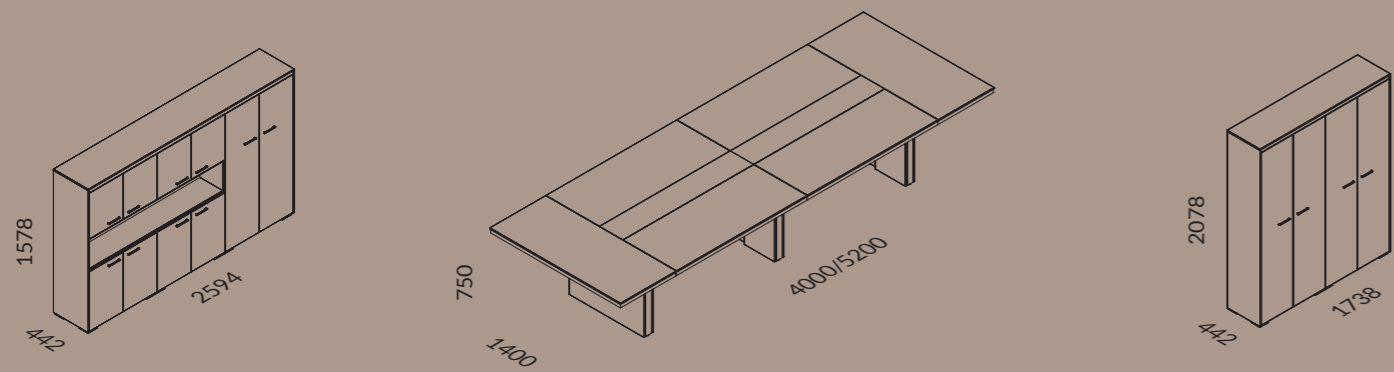

DR4
Melamina 3D
DĄB GÓRSKI SZARY
3D Melamine
SCANDINAVIAN OAK

Szko
CZARNE LACOBEL
Glass
BLACK LACOBEL

U1
Melamina
BIAŁY
Melamine
WHITE

Akcent
ALUMINIUM
SZCZOTKOWANE
Decorative strip
BRUSHED ALUMINUM







Ario

demand more

Dzięki zastosowaniu wyrazistych kamiennych okładzin, nawet najprostsze i minimalistyczne pomieszczenia zyskują piękny i niepowtarzalny charakter. Funkcjonalna szafka do wsparcia biurka ze zintegrowaną ładowarką indukcyjną sprawi, że każdy nowoczesny telefon będzie zawsze naładowany.

Thanks to the use of expressive stones, even the simplest and minimalist rooms will gain character. A functional cabinet for desk support with an integrated induction charger will ensure that every modern phone will always be fully charged.

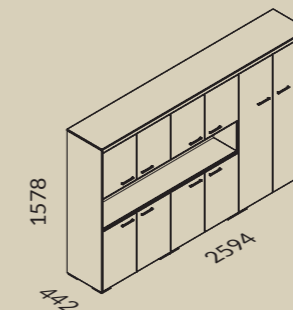
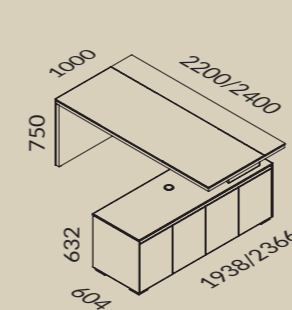

- | | | | |
|---|--|---|---|
|  | ST1
Kamień polerowany
NERO GRECO
Polished stone
NERO GRECO |  | Szkló
CZARNE LACOBEL
Glass
BLACK LACOBEL |
|  | U11
Melamina
GRAFIT
Melamine
GRAPHITE |  | LE3
Skóra naturalna
CZARNA
Natural leather
BLACK |
|  | U6
Melamina
SZARY PLATYNOWY
Melamine
PLATINUM GREY |  | Akcent
ALUMINIUM
SZCZOTKOWANE
Decorative strip
BRUSHED ALUMINUM |



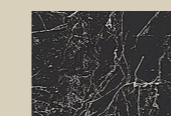
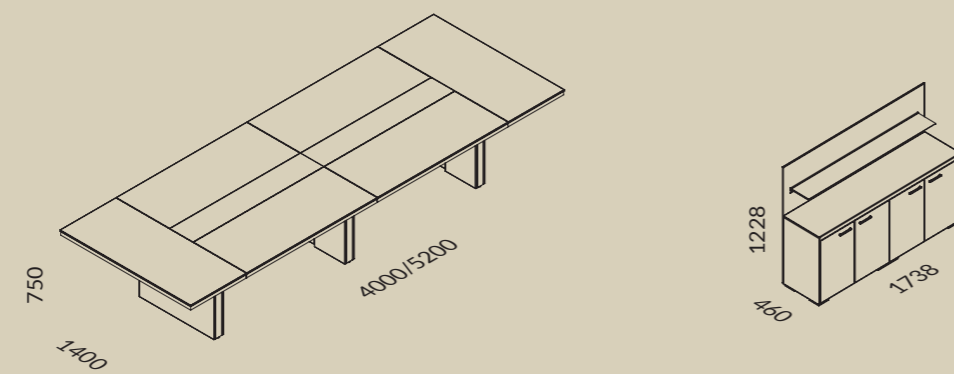

ST1
Kamień polerowany
NERO GRECO
Polished stone
NERO GRECO



U6
Melamina
SZARY PLATYNOWY
Melamine
PLATINUM GREY

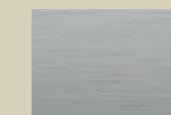

Akcent
ALUMINIUM
SZCZOTKOWANE
Decorative strip
BRUSHED ALUMINIUM

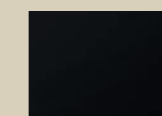

Szko
CZARNE LACOBEL
Glass
BLACK LACOBEL

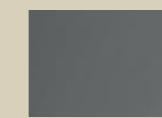

Szko
CZARNE OPTI
Glass
BLACK OPTI







Ario

demand more

Charyzmatyczne linie kolekcji wprawiają w zachwyt intensywną emanacją stylu i prestiżu – w szczególności, standardowe podświetlenie wnek szaf i witryn Ario, które nadaje większej wyrazistości oraz pozwoli wyeksponować wszystko, co ważne

Charismatic lines of the collection amaze with the intense emanation of style and prestige - in particular, the standard backlighting of the niches of Ario cabinets and credenza units, which highlights the design and allows you to display everything that is important.

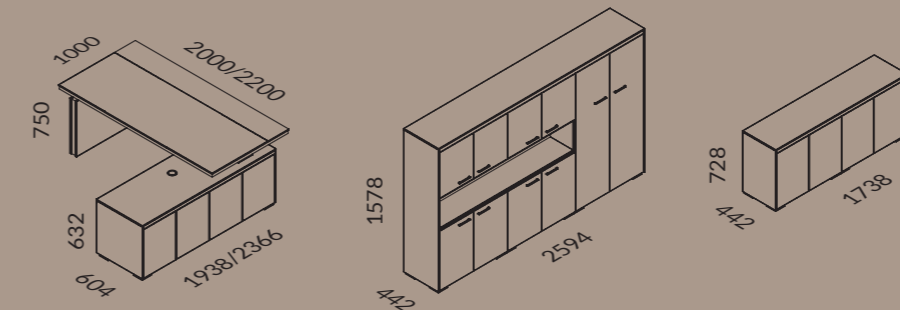

- | | | | |
|---|--|---|---|
|  | ST1
Kamień polerowany
NERO GRECO
Polished stone
NERO GRECO |  | LE1
Skóra naturalna
BRAZOWA
Natural leather
BROWN |
|  | DN2
Melamina 3D
WIAZ VERMONT
3D Melamine
VERMONT ELM |  | Szkoło
CZARNE LACOBEL
Glass
BLACK LACOBEL |
|  | U11
Melamina
GRAFIT
Melamine
GRAPHITE | | |





Ario

demand more

Wyraziste wnętrze zaprojektowane według własnej, wypracowanej definicji piękna to początek. Niebanalne formy mebli i akcesoriów oraz śmiałe zestawienia barw to dopełnienie charakteru i podkreślenie indywidualności każdego gabinetu.

The expressive interior designed according to your own, developed definition of beauty is the beginning. Original forms of furniture and accessories, as well as bold color combinations, complement the design and define the individuality of your office.

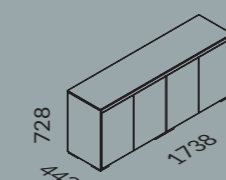
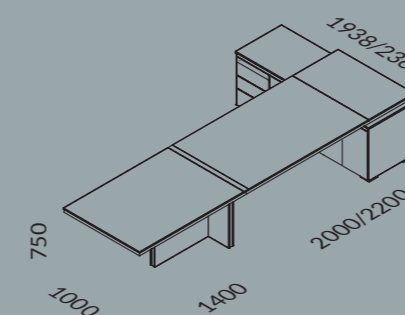

ST3
Kamień polerowany
BIANCO VENATO
Polished stone
BIANCO VENATO



U10
Melamina
BEZOWY KASZMIR
Melamine
BEIGE CASHMERE

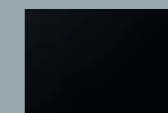

Szkło
CZARNE LACOBEL
Glass
BLACK LACOBEL

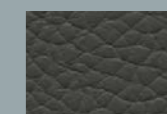

LE2
Skóra naturalna
GRAFITOWA
Natural leather
GRAPHITE



Akcent
ALUMINIUM
SZCZOTKOWANE
Decorative strip
BRUSHED ALUMINIUM

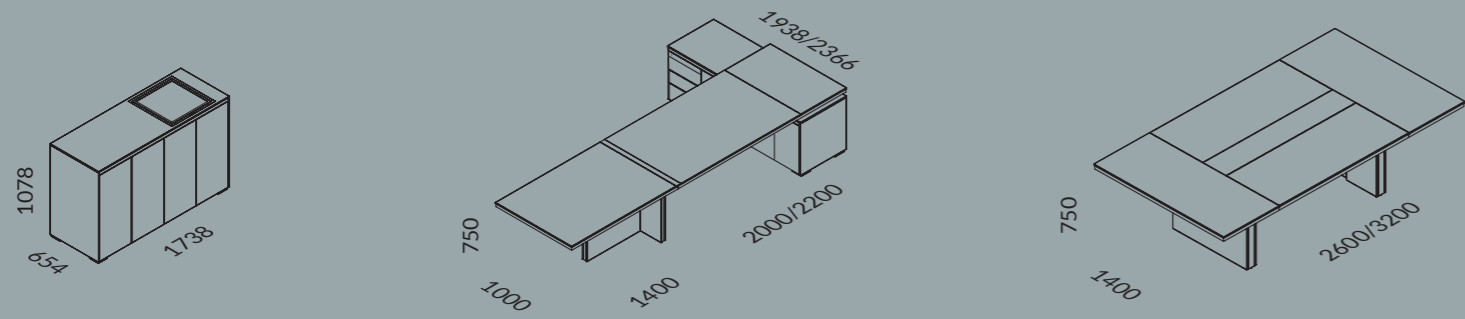

 ST3
 Kamień polerowany
 BIANCO VENATO
 Polished stone
 BIANCO VENATO

 U10
 Melamina
 BEŻOWY KASZMIR
 Melamine
 BEIGE CASHMERE

 Akcent
 ALUMINIUM
 SZCZOTKOWANE
 Decorative strip
 BRUSHED ALUMINUM

 Szkło
 CZARNE LACOBEL
 Glass
 BLACK LACOBEL



Ario



colors

BLAT / TOP SURFACE

Fornir / Veneer
Melamina 3D / 3D Melamine
Kamień polerowany / Polished stone

NOGA WEWNĘTRZNA / LEG INNER SIDE

Melamina / Melamine

STELAŻ / FRAME

Metal / Metal

AKCENT / DECORATIVE STRIP

ZABUDOWA / MODESTY PANEL

Szkoło Lacobel / Glass Lacobel
Fornir / Veneer
Melamina 3D / 3D Melamine
Kamień polerowany / Polished stone

WSTAWKI DO BLATÓW / TOP INSERTS

Szkoło Lacobel / Glass Lacobel
Skóra naturalna / Natural leather
Melamina / Melamine*

NOGA ZEWNĘTRZNA / LEG OUTER SIDE

Fornir / Veneer
Melamina 3D / 3D Melamine
Kamień polerowany / Polished stone

FRONTY WITRYN I SZAF / FRONT

Fornir / Veneer
Melamina 3D / 3D Melamine
Kamień polerowany / Polished stone
Melamina / Melamine
Szkoło Lacobel / Glass Lacobel

WNEKA / NICHE

Szkoło Lacobel / Glass Lacobel

PÓŁKA WITRYNY / SHOWCASE SHELF

Szkoło Opti / Glass Opti

KORPUS WITRYN I SZAF / CARCASS

Melamina / Melamine

OKŁADZINA GÓRNA / UPPER COVERS

Fornir / Veneer
Melamina 3D / 3D Melamine
Szkoło Lacobel / Glass Lacobel

OKŁADZINY BOCZNE / SIDE COVERS

Fornir / Veneer
Melamina 3D / 3D Melamine

FORNIR
/ VENEER



N04
Machoń Burundi / Burundi Mahogany

N05
Palisander Brazylijski / Brazilian Rosewood

N06
Dąb Flader / Flader Oak

MELAMINA 3D
/ 3D MELAMINE



DN1
Tectona Srebrzysta / Silver Teak

DN2
Wiąz Vermont / Vermont Elm

DR1
Orzech Madison / Madison Walnut

DR2
Kasztan Fumo / Fumo Chestnut

DR4
Dąb Górski Szary / Scandinavian Oak

KAMIEŃ POLEROWANY
/ POLISHED STONE

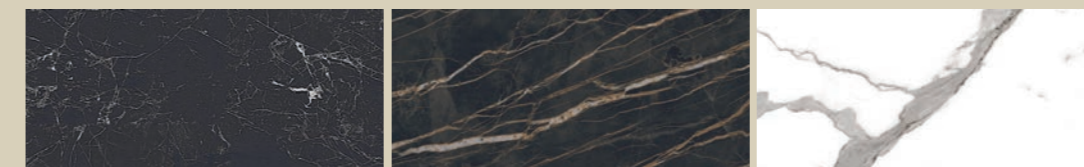

ST1
Nero Greco / Nero Greco

ST2
Noir Desir / Noir Desir

ST3
Bianco Venato / Bianco Venato

MELAMINA
/ MELAMINE

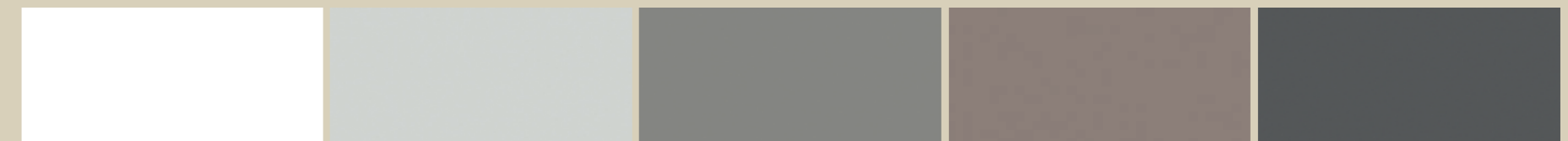

U1
Biały / White

U2
Popiel / Grey

U6
Szary Platynowy / Platinum Grey

U10
Beżowy Kaszmir / Beige Cashmere

U11
Grafit / Graphite

METAL
/ METAL

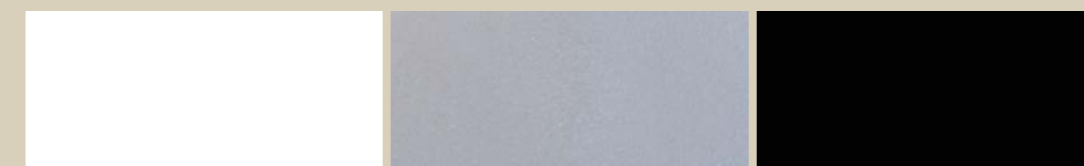

M02
Biały / White

M01
Aluminium / Aluminium

M04
Czarny / Black

AKCENT
/ DECORATIVE STRIP



Aluminium Szczotkowane
/ Brushed Aluminium

SZKOŁO LACOBEL
/ GLASS LACOBEL

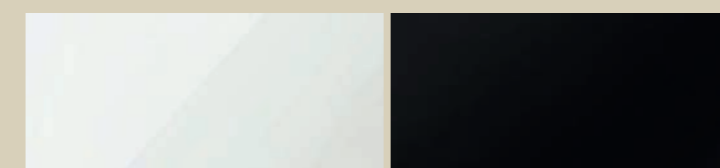

Białe Lacobel / White Lacobel

Czarne Lacobel / Black Lacobel

SZKOŁO OPTI
/ GLASS OPTI

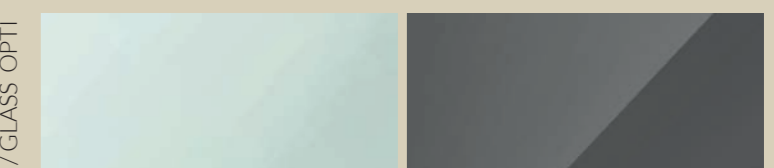

Białe Opti / White Opti

Czarne Opti / Black Opti

SKÓRA NATURALNA
/ NATURAL LEATHER

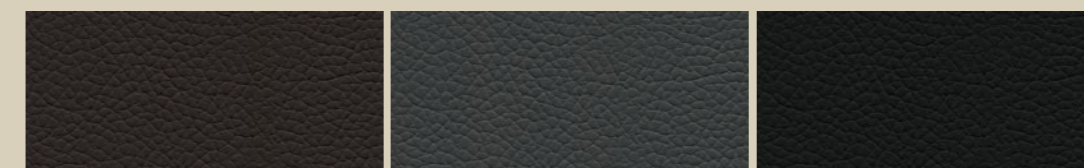

LE1
Brązowa / Brown

LE2
Grafitowa / Graphite

LE3
Czarna / Black

BIURKA GABINETOWE PROSTE / RECTANGULAR DESKS

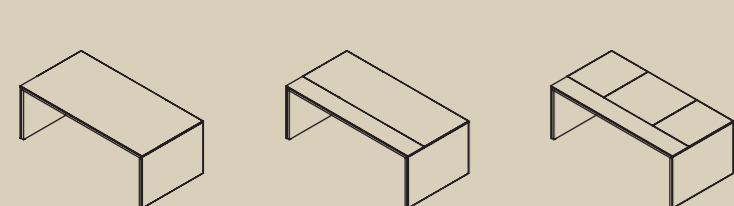

AR 03 2000/1000/750 AR 13 2000/1000/750 AR 23 2000/1000/750
AR 04 2200/1000/750 AR 14 2200/1000/750 AR 24 2200/1000/750

BIURKA GABINETOWE WSPARTE NA SZAFCE / DESKS SUPPORTED ON CABINET*

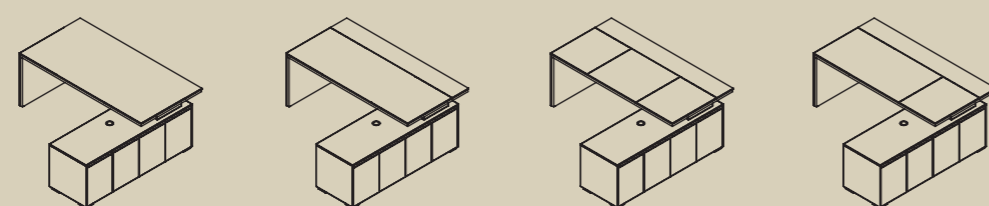

AR 07 2000/1000/750 AR 17 2000/1000/750 AR 27 2000/1000/750 AR 37 2000/1000/750
AR 08 2200/1000/750 AR 18 2200/1000/750 AR 28 2200/1000/750 AR 38 2200/1000/750

BIURKA Z PRZYSTAWKĄ / DESKS WITH A CONFERENCE EXTENSION

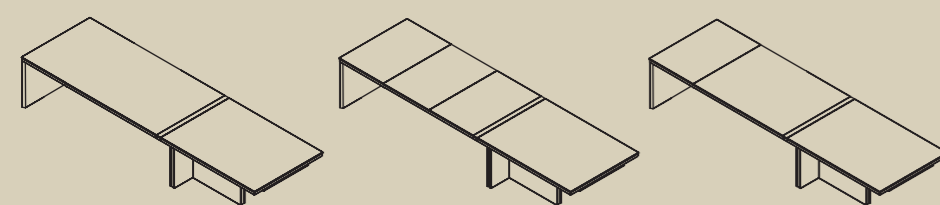

AR 69 3400/1000/750 AR 19 3400/1000/750 AR 29 3400/1000/750
AR 60 3600/1000/750 AR 10 3600/1000/750 AR 20 3600/1000/750

BIURKA ELEKTRYCZNE / DESKS WITH ELECTRIC HEIGHT ADJUSTMENT*

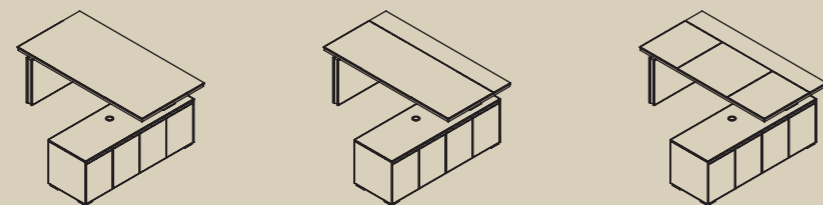

AE 03 2000/1000/750-1250 AE 13 2000/1000/750-1250 AE 23 2000/1000/750-1250
AE 04 2200/1000/750-1250 AE 14 2200/1000/750-1250 AE 24 2200/1000/750-1250

BIURKA Z PRZYSTAWKĄ WSPARTE NA SZAFCE / DESKS WITH A EXTENSION SUPPORTED ON CABINETS*

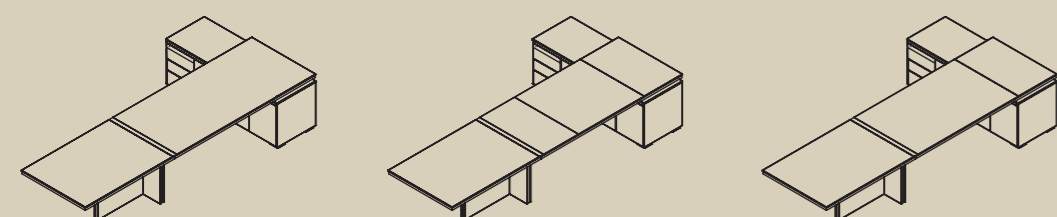

AR 39 3400/1000/750 AR 49 3400/1000/750 AR 59 3400/1000/750
AR 30 3600/1000/750 AR 40 3600/1000/750 AR 50 3600/1000/750

SZAFKI PODBIURKOWE / UNDERDESK CABINETS



AW 01 1738/604/632 AW 02 2166/604/632

ZABUDOWA / MODESTY PANELS

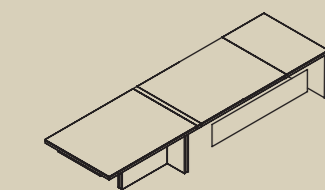

ZP 21 1800 ZP 22 1450 ZP 23 1250

KONTENERY MOBILNE / MOBILE PEDESTALS



AK 01 454/622/557 AK 02 454/622/557

STOLIKI KAWOWE / COFFE TABLES

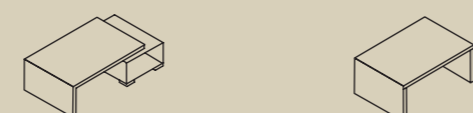

AT 81 1000/800/450 AT 71 1000/700/450
AT 82 1200/800/450 AT 72 1200/700/450
AT 83 1400/800/450 AT 73 1400/700/450

STOŁY KONFERENCYJNE / CONFERENCE TABLES

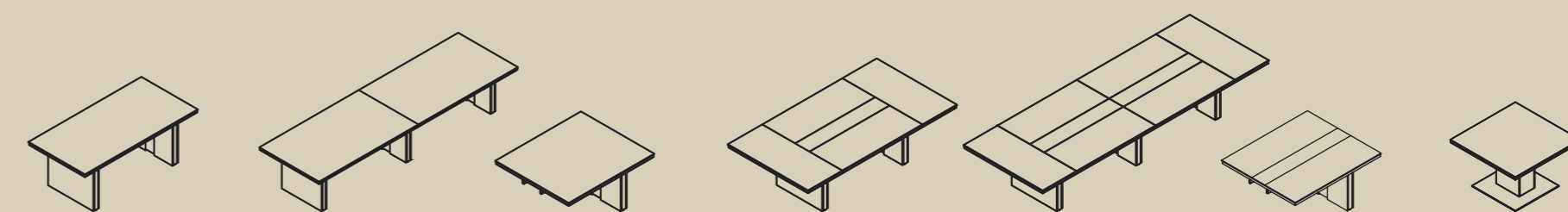

AT 11 2000/1000/750 AT 21 4000/1200/750 AT 22 1400/1200/750 AT 31 2600/1400/750 AT 41 4000/1400/750 AT 22 1400/1200/750
AT 12 2400/1000/750 AT 23 2000/1200/750 AT 32 3200/1400/750 AT 42 5200/1400/750 AT 23 2000/1200/750 AT 61 1200/1200/750

WITRYNY / SHOWCASES

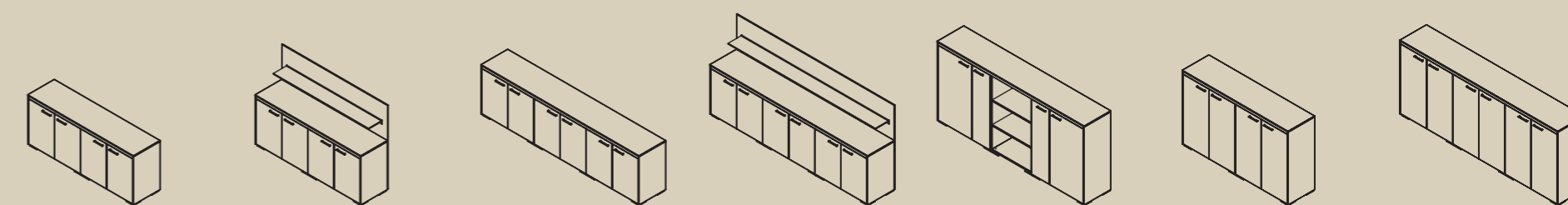

AC 11 1738/442/728 AC 12 1738/460/1228 AC 13 2594/442/728 AC 14 2594/460/1228 AC 01 2594/442/1078 AC 21 1738/442/1078 AC 22 2594/442/1078

WITRYNY / SHOWCASES

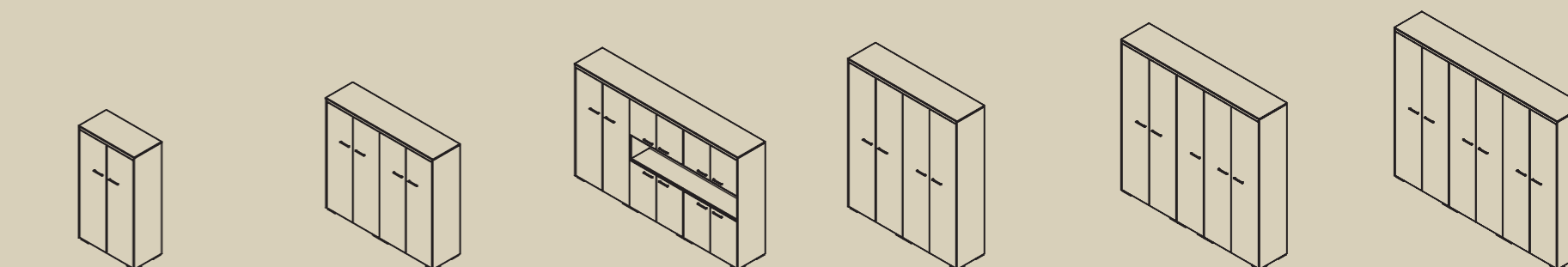

AC 31 882/442/1578 AC 32 1738/442/1578 AC 33 2594/442/1578 AC 41 1738/442/2078 AC 45 2166/442/2078 AC 43 2594/442/2078

SZAFKA TLEWIZYJNA / TV CABINET

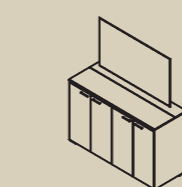

AC 51 1738/442/1078

BARKI / MINIBARS

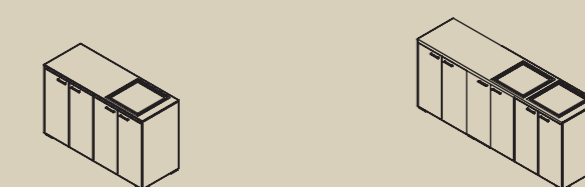

AC 61 1738/654/1078 AC 62 2594/654/1078



BIURKO Z ELEKTRYCZNĄ REGULACJĄ WYSOKOŚCI /
DESK WITH ELECTRIC HEIGHT ADJUSTMENT



SZAFKA TELEWIZYJNA /
TV CABINET



BAREK /
MINIBAR

System mebli gabinetowych Ario jest wyposażony w szereg udogodnień. W kolekcji znajdują się inteligentne, zautomatyzowane meble takie jak BIURKO Z ELEKTRYCZNĄ REGULACJĄ WYSOKOŚCI, które ułatwia troskę o właściwą postawę w czasie pracy. SZAFKA TELEWIZYJNA z mechanizmem pozwalającym łatwo ukryć telewizor, gdy nie jest potrzebny. Oraz MINIBAREK z miejscem na lodówkę, oraz wysuwaną platformą umożliwiającą bezproblemowy dostęp do porcelany, małego ekspresu kawowego, czajnika czy napojów.

Ario executive furniture system is equipped with numerous conveniences. The collection includes smart, automatically-operated furniture such as a DESK WITH ELECTRIC HEIGHT ADJUSTMENT, which helps to maintain the correct body posture during work. A TV CABINET with a mechanism that enables to retract the TV set while not in use and a MINI-BAR with a pull-out platform which allows for effortless access to tableware, a little coffee machine, a kettle, or beverages.



PILOT DO BIUREK ELEKTRYCZNYCH /
PILOT FOR DESK CONTROL



*** PRZELOTKA CHROMOWANA KABLOWA /**
CHROMED CABLE OUTLET



PILOT DO RYGIOWANIA ZAMKÓW /
REMOTE CONTROL FOR LOCK
OPERATION



UCHWYT (OPCJA BEZ DOPŁATY) /
HANDLE (OPTION WITHOUT
SURCHARGE)



*** MEDIAPORT /**
MEDIAPORT



ŁADOWARKA INDUKCYJNA /
INDUCTIVE CHARGER



PRZEGRODY DO SZUFLAD
W KONTENERZE MOBILNYM /
DRAWER DIVIDERS IN PEDESTALS



UKOŚNE PRZEGRODY DO SZUFLAD
W KONTENERZE MOBILNYM /
DIAGONAL FILING STORAGE IN
PEDESTALS



Fabryka Mebli Biurowych MARO Sp. z o. o.
PL 62-052 Komorniki, ul. Fabianowska 100
T +48 61 890 00 00
F +48 61 890 00 90
E maro@maro.pl

maro.pl

Informujemy o właściwościach i cechach materiałów naturalnych, forniru, kamienia i skóry naturalnej, takich jak: zmienność barwy w obrębie jednego elementu, przeżycienia, nieregularnego usłojenia, mikropeknięcia, dziurki oraz o tym, że nie są to ich wady, lecz zalety. Sprawiają one, że elementy wykonane z naturalnych komponentów, posiadają unikalny i niepowtarzalny charakter dekoracyjny. Fornir dodatkowo, jest nieodporny na ciepło oraz zmienia swoją barwę pod wpływem promieniowania słonecznego. Więcej informacji można znaleźć w instrukcji 'Pielęgnacja i konserwacja mebli MARO'.

We would like to inform you about the properties and characteristics of natural materials - veneer, stone and natural leather - such as: changeability of the color of a single element, irregular veins/graining, microcracks, holes and about the fact that they are not their disadvantages but advantages. This makes the elements made of natural components, have unique and decorative character. Veneer is not resistant to heat and changes its color when exposed to the sunlight. For more information, check 'Taking care of your MARO furniture' manual.

Niniejsza publikacja nie stanowi oferty w rozumieniu prawnym. MARO zastrzega sobie prawo wprowadzenia zmian w ofertowanych meblach. Prezentowane kolory mogą odbiegać od rzeczywistości. Wszystkie wzory chornione są w Urzędzie Patentowym RP

This publication does not constitute an offer in legal terms. MARO reserves the right to introduce changes to the offered furniture. Presented colors may differ from reality. All designs are protected by the Polish Patent Office

© MARO 12/20

Fabryka Mebli Biurowych MARO

maro.pl